

FEATURES

- Three-way solenoid valves with orifice and pipe connections in valve body enabling convenient installation
- Compact valve intended for single-acting actuator control
- Epoxy moulded coil for general service applications
- Coils interchangeable without dismantling the valve
- Valves do not require a minimum operating pressure
- The solenoid valves satisfy all relevant EC directives

GENERAL

Differential pressure See "SPECIFICATIONS" [1 bar =100 kPa]
Maximum viscosity 40 cSt (mm²/s)
Response time 5 - 20 ms

fluids (*)	temperature range (TS)	seal materials (*)
water, air, inert gas, oil	- 25°C to + 80°C	NBR (nitrile) VMQ (silicone)

MATERIALS IN CONTACT WITH FLUID

(*) Ensure that the compatibility of the fluids in contact with the materials is verified

Body Brass or AISI 316L (1.4404)
Internal parts Stainless steel - plastic
Springs Stainless steel
Seats Brass
Disc holder and core guide POM
Discs NBR(FPM or EPDM)
O'rings VMQ
Shading coil Copper

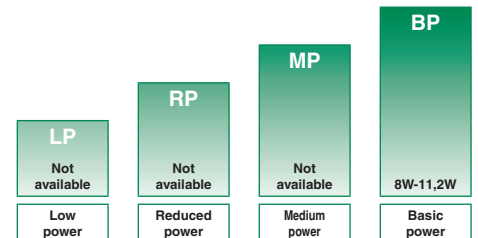
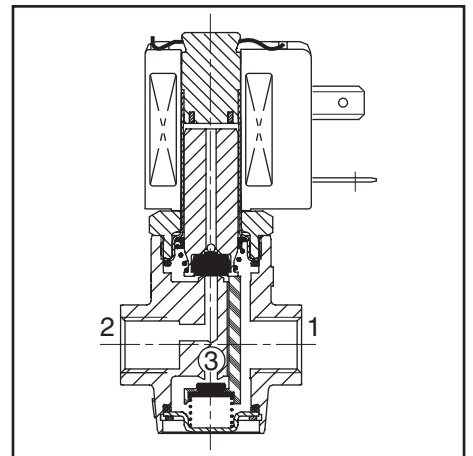

POWER LEVELS - cold electrical holding values (watt)

SPECIFICATIONS

pipe size	orifice size	flow coefficient Kv		operating pressure differential (bar)			power level BP		prefix optional solenoids					basic catalogue number	
				min.	max. (PS)				ATEX / IECEx				IP65		
					air/water/oil (*)				Ex d	Ex emb	Ex mb	-			
(*)	(mm)	(m ³ /h)	(l/min)		~	=	~	=	NF	EM	PV	-	SC	brass	stainless st.
NC - Normally closed															
1/4	2,0	0,11	1,8	0	16	-	8	-	-	-	-	-	●	❖370A001	❖370A031
1/4	2,0	0,11	1,8	0	-	8	-	10,8	-	-	-	-	●	❖370A061	❖370A070
1/4	2,0	0,11	1,8	0	16	16	10,5	11,2	●	●	●	-	●	❖370A016	❖370A046
1/4	2,7	0,20	3,3	0	10	-	8	-	-	-	-	-	●	❖370A002	❖370A032
1/4	2,7	0,20	3,3	0	-	5	-	10,8	-	-	-	-	●	❖370A062	❖370A071
1/4	2,7	0,20	3,3	0	10	10	10,5	11,2	●	●	●	-	●	❖370A017	❖370A047
1/4	3,8	0,30	5,0	0	5	-	8	-	-	-	-	-	●	❖370A003	❖370A033
1/4	3,8	0,30	5,0	0	-	2	-	10,8	-	-	-	-	●	❖370A063	❖370A072
1/4	3,8	0,30	5,0	0	5	5	10,5	11,2	●	●	●	-	●	❖370A018	❖370A048

❖ Select **B** for NPT ANSI 1.20.3
 Select **E** for ISO (228/1 and ISO 7/1)

● Available feature

- Not available

SPECIFICATIONS

pipe size	orifice size	flow coefficient Kv		operating pressure differential (bar)				power level BP		prefix optional solenoids					basic catalogue number	
				min.	max. (PS)		ATEX / IECEx									
					air/water/oil (*)		Ex d			Ex emb	Ex mb	-	IP65			
(*)	(mm)	(m³/h)	(l/min)	~	=	~	=	NF	EM	PV	-	SC	brass	stainless st.		
U - Universal																
1/4	2,0	0,11	1,8	0	8	-	8	-	-	-	-	-	●	❖370A011	❖370A041	
1/4	2,0	0,11	1,8	0	-	4	-	10,8	-	-	-	-	●	❖370A064	❖370A073	
1/4	2,0	0,11	1,8	0	8	8	10,5	11,2	●	●	●	-	●	❖370A026	❖370A056	
1/4	2,7	0,20	3,3	0	5	-	8	-	-	-	-	-	●	❖370A012	❖370A042	
1/4	2,7	0,20	3,3	0	-	2	-	10,8	-	-	-	-	●	❖370A065	❖370A074	
1/4	2,7	0,20	3,3	0	5	5	10,5	11,2	●	●	●	-	●	❖370A027	❖370A057	
1/4	3,8	0,30	5,0	0	2	-	8	-	-	-	-	-	●	❖370A013	❖370A043	
1/4	3,8	0,30	5,0	0	-	0,5	-	10,8	-	-	-	-	●	❖370A066	❖370A075	
1/4	3,8	0,30	5,0	0	2	2	10,5	11,2	●	●	●	-	●	❖370A028	❖370A058	
NO - Normally open																
1/4	2,0	0,11	1,8	0	10	-	8	-	-	-	-	-	●	❖370A006	❖370A036	
1/4	2,0	0,11	1,8	0	10	10	10,5	11,2	●	●	●	-	●	❖370A021	❖370A051	
1/4	2,7	0,20	3,3	0	7	-	8	-	-	-	-	-	●	❖370A007	❖370A037	
1/4	2,7	0,20	3,3	0	7	7	10,5	11,2	●	●	●	-	●	❖370A022	❖370A052	
1/4	3,8	0,30	5,0	0	3	-	8	-	-	-	-	-	●	❖370A008	❖370A038	
1/4	3,8	0,30	5,0	0	3	3	10,5	11,2	●	●	●	-	●	❖370A023	❖370A053	

PREFIX TABLE

prefix							description	power level			
1	2	3	4	5	6	7		LP	RP	MP	BP
E	M						Waterproof IP67 - Metal enclosure (EN/IEC 60079-7+18, 61241-1)*	-	-	-	● ⁽¹⁾
		E	T				Threaded conduit/hole (M20 x 1,5)	-	-	-	● ⁽¹⁾
N	F						Flameproof - Aluminium (EN/IEC 60079-1, 60079-31*	-	-	-	● ⁽¹⁾
P	V						Encapsulated epoxy moulded (EN/IEC 60079-18, 61241-18)*	-	-	-	● ⁽¹⁾
S	C						Solenoid with spade plug connector (EN/IEC 60730)	-	-	-	● ⁽¹⁾
W	P						Waterproof IP67 - Metal enclosure	-	-	-	● ⁽¹⁾
W	S						Waterproof IP67 - 316 SS enclosure	-	-	-	● ⁽¹⁾
W	S	E	M				Waterproof IP67 - 316 SS enclosure (EN/IEC 60079-7+18, 61241-1)*	-	-	-	● ⁽¹⁾
W	S	N	F				Flameproof - 316L SS (EN/IEC 60079-1, 60079-31)*	-	-	-	● ⁽¹⁾
				H	T		Threaded conduit (1/2" NPT)	-	-	-	● ⁽¹⁾
						X	Class H - High temperature	-	-	-	● ⁽¹⁾
							Other special constructions	-	-	-	● ⁽¹⁾

SUFFIX TABLE

suffix					description	power level			
1	2	3	4	5		LP	RP	MP	BP
E					EPDM (ethylene-propylene)	-	-	-	●
V					FPM (fluoroelastomer)	-	-	-	●
N	V				FPM (fluoroelastomer) and parts cleaned for oxygen service	-	-	-	●
		M	S		Screw type manual operator	-	-	-	●
		M	O		Brass version: Push type manual operator	-	-	-	●

OPTIONS & ACCESSOIRES

catalogue number	spare parts kit n°(2)		screw type manual operator
	~	=	
❖370A001/002/003	C140044	-	C140048
❖370A031/032/033	C140044	-	C140072
❖370A061/062/063	-	C140043	C140048
❖370A070/071/072	-	C140043	C140072
❖370A016/017/018	C140044	C140044	C140048
❖370A046/047/048	C140044	C140044	C140072
❖370A011/012/013	C140047	-	C140048
❖370A041/042/043	C140047	-	C140072
❖370A064/065/066	-	C140046	C140048
❖370A073/074/075	-	C140046	C140072
❖370A026/027/028	C140047	C140047	C140048
❖370A056/057/058	C140047	C140047	C140072

❖ Select **B** for NPT ANSI 1.20.3 or select **E** for ISO (228/1 and 7/1)

● Available feature

- Not available

* ATEX solenoids are also approved according to EN 13463-1 (non electrical valves)

(1) Power level 10,5/11,2: Available feature, see Specifications page 1

(2) Standard suffixes E and V are also applicable to kits

(3) Basic kit number applies to SC coil construction

PRODUCT SELECTION GUIDE

STEP 1

Select basic catalogue number, including pipe thread identification letter. Refer to the specifications tables on pages 1 and 2.

Example: E370A016

STEP 2

Select prefix (combination). Refer to the specifications table on page 1 and the prefix table on page 2, respect the indicated power level.

Example: EM

STEP 3

Select suffix (combination) if required. Refer to the suffix table on page 2, respect the indicated power level.

Example: MS

STEP 4

Select voltage. Refer to standard voltages on page 3.

Example: 230V / 50Hz

STEP 5

Final catalogue / ordering number.

Example:

EME370A016MS 230 V / 50 Hz

ORDERING EXAMPLES VALVES:

SC	E	370 A	046	MS	230V / 50 Hz
SCHT	B	370 A	018		230V / 50 Hz
WS	E	370 A	048	MS	24V / DC
WP	B	370 A	017		24V / DC
EM	B	370 A	031	MO	230V / 50 Hz

prefix — pipe thread — basic number — voltage — suffix

ORDERING EXAMPLES KITS:

C140044	(3)
C140043	V
C140047	E

basic number — suffix

EXPLANATION OF TEMPERATURE RANGES OF SOLENOID VALVES

Valve temperature range	The valve temperature range (TS) is determined by the selected seal material, the temperature range for proper operation of the valve and sometimes by the fluid (e.g. steam)
Operator ambient temperature range	The operator ambient temperature range is determined by the selected power level and the safety code
Total temperature range	The temperature range of the complete solenoid valve is determined by the limitations of both temperature ranges above

ELECTRICAL CHARACTERISTICS

Coil insulation class	F
Electrical safety	IEC 335
Standard voltages	DC (=) 24V - 48V AC (~) 24V - 48V - 115V - 230V/50Hz; other voltages and 60Hz are available on request

prefix option	power ratings			operator ambient temperature range (TS) (C°)	safety code	electrical enclosure protection (EN 60529)	replacement coil / kit		type ⁽²⁾	
	inrush ~ (VA)	holding ~ (VA)	hot/cold = (W)				~	=		
							230V/50 Hz	24V/DC		
Basic power (BP)										
SC	23	14	8	8/10,8	-25 to +60	EN 60730	moulded IP65	43005096	43005099	01-02
SC	55	23	10,5	9/11,2	-40 to +75	EN 60730	moulded IP65	400425-117	400425-142	03-04
WP	55	23	10,5	9/11,2	-40 to +75	EN 60730	steel IP67	400405-117	400405-142	09-10
WS	55	23	10,5	9/11,2	-40 to +75	EN 60730	st. steel IP67	400405-117	400405-142	09-10
(WS)NF	55	23	10,5	-	[-60] ⁽¹⁾ -40 à +25/40/60	II 2G/D Ex d IIC T6/T5/T4/Ex t	alu/steel IP67	400405-117	-	05-06
(WS)NF	-	-	-	9/11,2	[-60] ⁽¹⁾ -40 à +40/60/75	II 2G/D Ex d IIC T6/T5/T4/Ex t	alu/steel IP67	-	400405-142	05-06
EM/WSEM	55	23	10,5	9/11,2	-40 to +40	II 2G/D Ex emb II T3/Ex tD	steel/SS IP67	400909-117	400913-142	09-10
PV	55	23	10,5	9/11,2	-40 to +65	II 2G/D Ex mb II T3(-)/T4(=)/Ex mD	moulded IP65	- ⁽³⁾	- ⁽³⁾	11-12

- Not available
- ⁽¹⁾ The certified minimum temperature of this operator
- ⁽²⁾ Refer to the dimensional drawings on pages 4 to 6
- ⁽³⁾ Multiple coil kits available under ATEX, contact us

ELECTRICAL CONNECTIONS

prefix	connection
SC	Spade plug connector with cable gland EN175301-803A (ISO 4400) for cables with an outer diameter from 6 to 10 mm.
WP, WS, EM, WSEM	M22 cable gland for cables with an outer diameter from 7 to 12 mm. With an internal and external facility for an earthing or bonding conductor.
NF, WSNF	1/2" NPT threaded cable entry. Enclosures are supplied without cable gland.
PV	Moulded-in cable, standard length 2 m

ADDITIONAL OPTIONS

- Mounting holes on stainless steel version: 2 ØM4, 7 mm depth, TPL23012
- Other pipe threads are available on request
- Ex mb (prefix "PV") execution can be supplied in various cable lengths
- Compliance with "UL", "CSA" and other local approvals available on request
- 1/2" NPT (prefix "T") and M20 x 1.5 (prefix "ET") conduits (aluminium or 316 SS) available for steel solenoid housing

INSTALLATION

- Installation/maintenance instructions are included with each valve
- The solenoid valves can be mounted in any position without affecting operation
- Threaded pipe connection identifier is: B = NPT (ANSI 1.20.3); E = (ISO 228/1 and ISO 7/1)
- Prefix "(WS)NF" enclosure is provided with a 1/2" NPT threaded entry hole [optionally, M20 x 1,5 (prefix "ET")] and is supplied without cable gland

DIMENSIONS (mm), WEIGHT (kg)



TYPE 01:
SC
Epoxy moulded
IEC 335 / ISO 4400

370A001 / 061 / 002 / 062 / 003 / 063 / 011 / 064
370A012 / 065 / 013 / 066 / 006 / 007 / 008

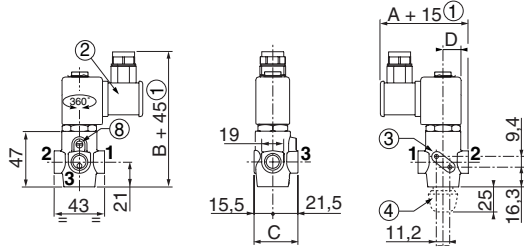

TYPE 02:
SC
Epoxy moulded
IEC 335 / ISO 4400

370A031 / 070 / 032 / 071 / 033 / 072 / 041 / 073 / 042
370A074 / 043 / 075 / 036 / 037 / 038

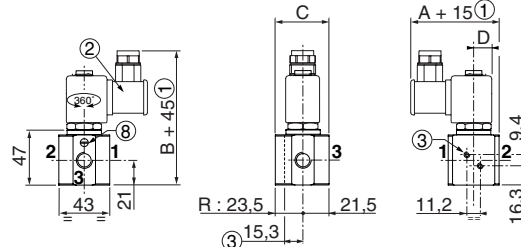

Pressure inlet:

- Function U = any port
 - Function NC = Port 2
 - Function NO = Port 3
- Ports 1, 2 and 3 : 1/4



TYPE 03:
SC
Epoxy moulded
IEC 335 / ISO 4400

370A016 / 017 / 018 / 026 / 027 / 028
370A021 / 022 / 023

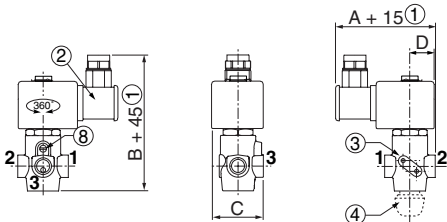

TYPE 04:
SC
Epoxy moulded
IEC 335 / ISO 4400

370A046 / 047 / 048 / 056 / 057 / 058
370A051 / 052 / 053

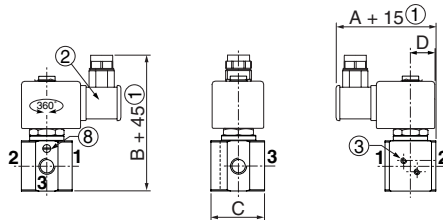

TYPE 05:
NF / WSNF
Aluminium; epoxy coated / AISI 316L SS
EN/IEC 60079-1 and EN/IEC 60079-31

370A016 / 017 / 018 / 026 / 027 / 028
370A021 / 022 / 023

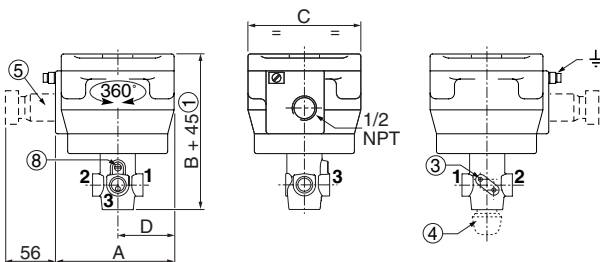

TYPE 06:
NF / WSNF
Aluminium; epoxy coated / AISI 316L SS
EN/IEC 60079-1 and EN/IEC 60079-31

370A046 / 047 / 048 / 056 / 057 / 058
370A051 / 052 / 053

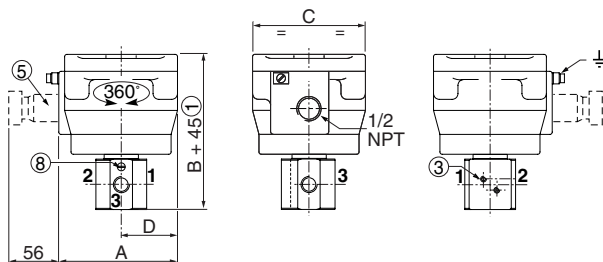

DIMENSIONS (mm), WEIGHT (kg) 



TYPE 09:
 WP / WS
 EM / WSEM
 Steel; epoxy coated / AISI 316 SS
 IEC 335 / EN/IEC 60079-7/18 and EN/IEC 61241-1

370A016 / 017 / 018 / 026 / 027 / 028
 370A021 / 022 / 023



TYPE 10:
 WP / WS
 EM / WSEM
 Steel; epoxy coated / AISI 316 SS
 IEC 335 / EN/IEC 60079-7/18 and EN/IEC 61241-1

370A046 / 047 / 048 / 056 / 057 / 058
 370A051 / 052 / 053

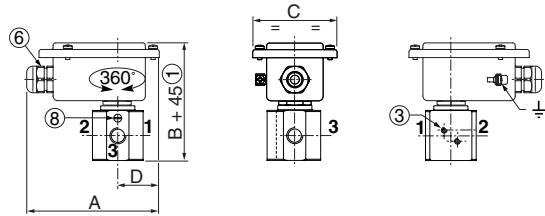
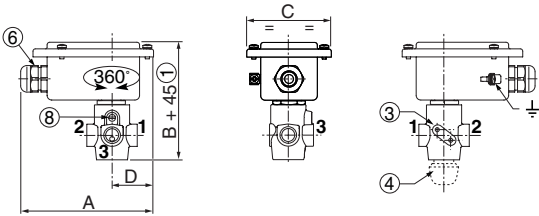

TYPE 11:
 PV
 Epoxy encapsulated
 EN/IEC 60079-18 and EN/IEC 61241-18

370A016 / 017 / 018 / 026 / 027 / 028
 370A021 / 022 / 023



TYPE 12:
 PV
 Epoxy encapsulated
 EN/IEC 60079-18 and EN/IEC 61241-18

370A046 / 047 / 048 / 056 / 057 / 058
 370A051 / 052 / 053

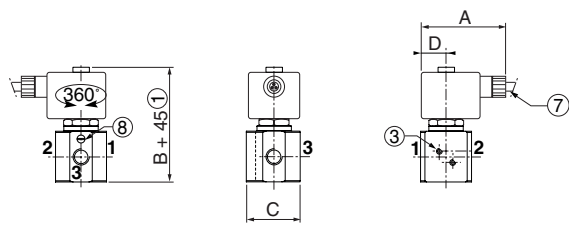
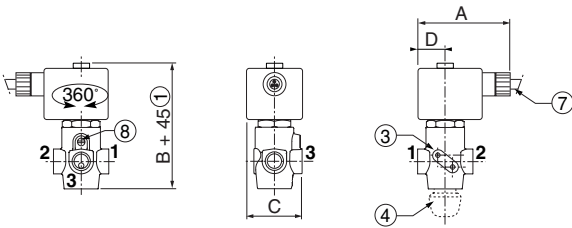

DIMENSIONS (mm), WEIGHT (kg)

type	prefix option	power level	A	B	C	D	weight ⁽¹⁾
01	SC	Basic Power	76,5	116	37	15	0,430
02	SC	Basic Power	76,5	116	45	15	0,670
03	SC	Basic Power	85,5	116	44	21	0,600
04	SC	Basic Power	85,5	116	45	21	0,820
05	NF	Basic Power	102	136	97	48,5	1,700
05	WSNF	Basic Power	102	136	97	48,5	3,000
06	NF	Basic Power	102	136	97	48,5	1,920
06	WSNF	Basic Power	102	136	97	48,5	3,220
09	WP/WS/EM/WSEM	Basic Power	120	109	77	38	0,850
10	WP/WS/EM/WSEM	Basic Power	120	109	77	38	1,070
11	PV	Basic Power	75	96,4	45	21,5	0,648
12	PV	Basic Power	75	96,4	45	21,5	0,868

⁽¹⁾ Incl.coil(s) and connector(s)

- ① Extra length for disassembly, depending on model
- ② Connector rotatable by 90° increments (cable Ø 6 - 10 mm)
- ③ Option: Mounting 2 ØM4, 7 mm depth, TPL 23012 on stainless steel version
- ④ Push type manual operator, suffix MO
- ⑤ Ex d certified cable gland (on request)
- ⑥ Cable gland for unarmoured cable with 6 to 12 mm dia. sheath
- ⑦ Three-core cable, length 2 m
- ⑧ Screw type manual operator, suffix (MS)

SECTIONAL DRAWING

