

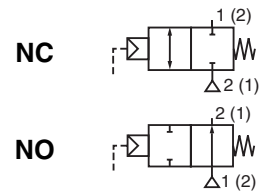

VALVES

pressure operated
stainless steel body

with socket welding ends PN40, DN 15 to 50



2/2
Series
S298

FEATURES

- Ruggedly built valve, particularly recommended for use with steam, superheated water, corrosive fluids
- High-performance, maintenance-free stuffing box, resistant to thermal shock
- Pressure can be applied to any port as needed by the process
- Anti-waterhammer design (fluid entry at orifice 1), recommended for use with liquids
- Vacuum operation up to 10^{-2} mbar
- Allowable backpressure: up to 40 bar
- Optical position indicator as standard
- Autoclavable valve for use at high ambient temperatures (up to 180°C)
- The valves satisfy Pressure Equipment Directive 97/23/EC, category 1 (DN > 32) or article 3.3 (DN ≤ 32)

GENERAL

Differential pressure	0 to 40 bar [1 bar = 100 kPa]
Maximum allowable pressure	40 bar (within the specified limits, see diagram I)
Ambient temperature range	-25°C to +180°C
Maximum viscosity	5000 cSt (mm ² /s)
Pilot fluid	Air
Max. pilot pressure	10 bar
Min. pilot pressure	See below



fluids (*)	temperature range	disc seal (*)
DN 15-20-25: air and gas groups 1 & 2 DN 32-40-50: air and gas group 2 all DN: water, oil, liquids groups 1 & 2 and steam	- 10°C to + 250°C	bronze PTFE

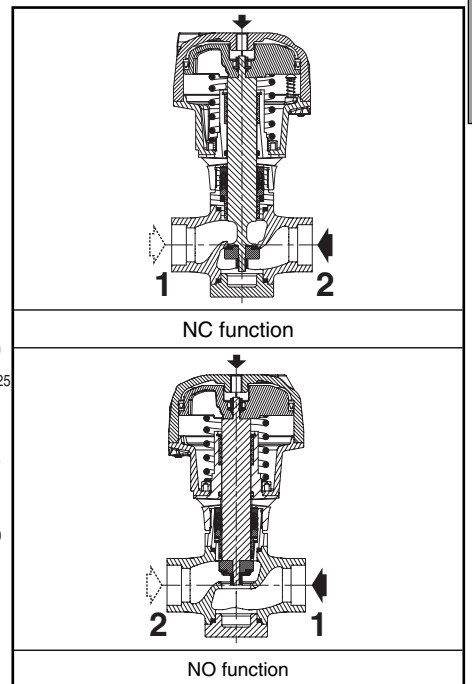
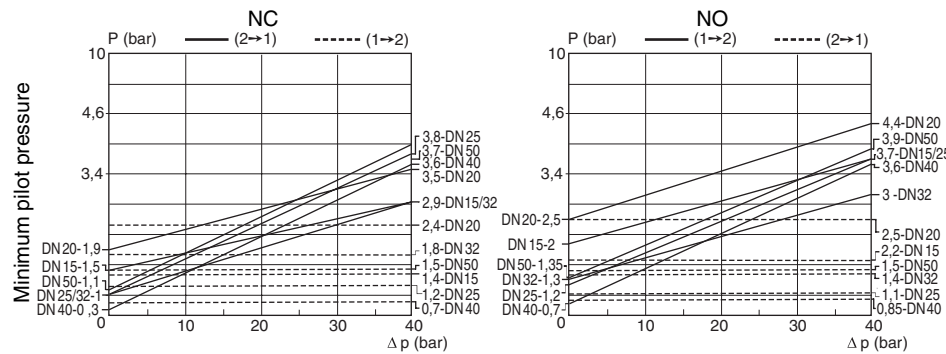

CONSTRUCTION

Socket welding ends EN 12760

MATERIALS IN CONTACT WITH FLUID

(*) Ensure that the compatibility of the fluids in contact with the materials is verified

Body and plug	Stainless steel
Stuffing box housing	Stainless steel
Stem, disc	Stainless steel
Stuffing box packing	PTFE chevrons
Disc seal	Bronze PTFE
Valve body seal	Graphite

OTHER MATERIALS

Operator Aluminium, nickel plated

SPECIFICATIONS

DN	ext. pipe diameter (mm)	flow coefficient Kv				pilot pressure (bar)		operating pressure differential (bar)	operator diameter (mm)	catalogue number
		1 → 2		2 → 1		min.	max.			
		(m ³ /h)	(l/min)	(m ³ /h)	(l/min)					
NC - Normally closed										
15	22,4	4,4	73	5	83	*	10	40	80	S298A001
20	27,7	7,7	128	8,5	142	*	10	40	100	S298A002
25	34,5	11,5	192	12	200	*	10	40	100	S298A003
32	43,2	18	300	18	300	*	10	40	150	S298A004
40	49,5	29	483	29	483	*	10	40	150	S298A005
50	62	57	950	57	950	*	10	40	200	S298A006

* Minimum pilot pressure varies with differential pressure. See piloting chart above.

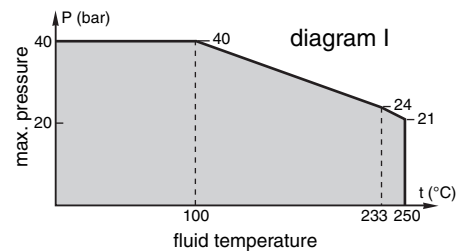

SPECIFICATIONS

DN	ext. pipe diameter (mm)	flow coefficient Kv				pilot pressure (bar)		operating pressure differential (bar)	operator diameter (mm)	catalogue number
		1 → 2		2 → 1		min.	max.			
		(m³/h)	(l/min)	(m³/h)	(l/min)					
15	22,4	3,5	58	3,5	58	*	10	40	80	S298A007
20	27,7	7,2	120	7	117	*	10	40	100	S298A008
25	34,5	11	183	11	183	*	10	40	100	S298A009
32	43,2	18	300	15	250	*	10	40	150	S298A010
40	49,5	28,2	470	28,2	470	*	10	40	150	S298A011
50	62	53	883	53	883	*	10	40	200	S298A012

* Minimum pilot pressure varies with differential pressure. See piloting chart above.

OPTIONS AND ACCESSORIES

- Metal-to-metal sealing disc
- ATEX 94/9/EC versions for potentially explosive atmospheres, categories 2 GD and 3 GD
- Valve seat leakage class VI as defined by FCI 70-2, contact us
- Other pipe connections are available on request

INSTALLATION

- The valves can be mounted in any position without affecting operation
- Compatible with ASTM 1, 2 and 3 oils
- The socket welding ends are according to EN 12760
- Installation/maintenance instructions are included with each valve

SPARE PARTS KITS

catalogue number	spare parts kit no.		
	piston seal	actuator spring	stem, disc, seals
S298A001	C140233	C140299	C140311
S298A002	C140234	C140301	C140313
S298A003	C140234	C140303	C140315
S298A004	C140235	C140305	C140317
S298A005	C140235	C140307	C140319
S298A006	C140298	C140309	C140321
S298A007	C140233	C140300	C140312
S298A008	C140234	C140302	C140314
S298A009	C140234	C140304	C140316
S298A010	C140235	C140306	C140318
S298A011	C140235	C140308	C140320
S298A012	C140298	C140310	C140322

ORDERING EXAMPLES:

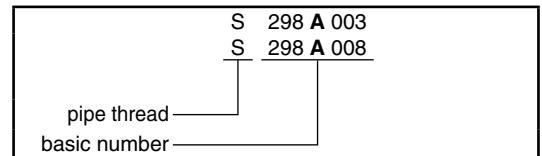

ORDERING EXAMPLES KITS:

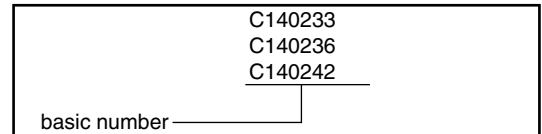

DIMENSIONS (mm), WEIGHT (kg)



TYPE 01-02-03-04
Prefix "S"

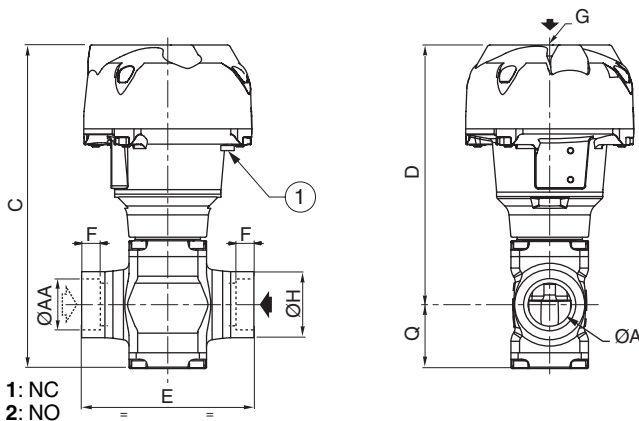

① Optical position indicator

type	DN	operator diameter	ØA	ØAA	ØB	C	D	E	F	G	ØH	ØP	Q	weight	
														NC	NO
01	15	80	15	22,4	110	184,1	151,6	85	9,5	G 1/8	33	95	32,5	1,81	1,79
02	20	100	20	27,7	132,5	209,9	170,9	110	11	G 1/8	40	117	39	3,43	3,45
	25	100	25	34,5	132,5	225,4	180,9	120	12,5	G 1/8	46	117	44,5	4,15	4,11
03	32	150	32	43,2	191	291,2	237,2	145	14,5	G 1/4	57	172,5	54	9,31	9,25
	40	150	40	49,5	191	325,7	259,2	150	16	G 1/4	65	172,5	66,5	11,38	11,36
04	50	200	50	62	247	409	328,5	190	17,5	G 1/4	75	230	80,5	23,48	21,68