

Rotary/lifting modules EHMB, electric



# Rotary/lifting modules EHMB, electric

Features

## At a glance

The rotary/lifting module EHMB combines rotary and linear motion in one compact unit. The rotation is always transferred through a toothed belt to a hollow shaft by an electric motor while the linear motion is generated either by a pneumatic cylinder DSBC or an

electric cylinder ESBF. Both movements act on the output flange, which is compatible with the semi-rotary drive DRQD, so that numerous grippers can be used. Cables and tubes can be easily routed

to the front unit of the rotary/lifting module through the large hollow shaft. The movement range can also be sensed via proximity sensors at the rotary unit and the cylinder.

Advantages :

- Large hollow axis
- Stable bearing arrangement
- Various motors and cylinders enable the performance to be adapted to the application

## The technology in detail

- 1 Stop nut
- 2 Grooved shaft guide
- 3 Through-hole for mounting
- 4 Mounting thread/mounting hole
- 5 Output flange with centring hole and threaded hole for payload. Interface corresponds to that of the pneumatic semi-rotary drive DRQD
- 6 Drive shaft for rotation
- 7 Cylinder retainer
- 8 Rod eye and connecting bolt for linear motion

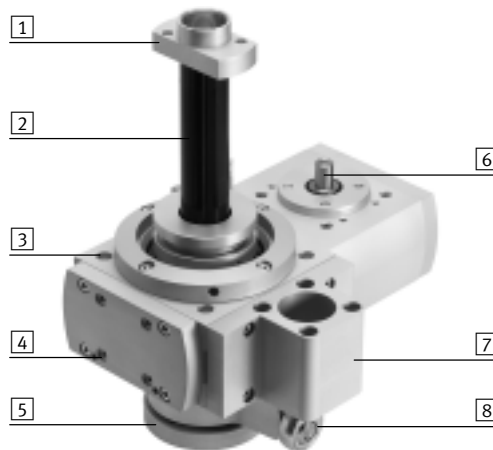

## Flexible connection

Orientation:

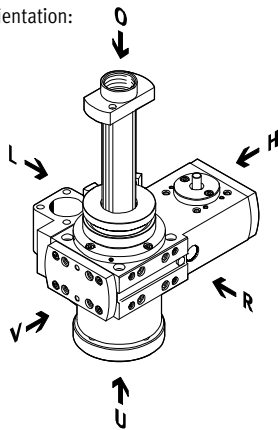

- O= top  
 U= underneath  
 R= right  
 V= front  
 L= left  
 H= rear

- The rotary/lifting module EHMB can be mounted on four sides:
  - On the right or left of the housing (L, R)
  - On the front cover (V)
  - Underneath the housing (U)
- The cylinder retainer can be mounted on three sides:
  - On the right or left of the housing (L, R)
  - On the front, after removing the front cover (V)
- The side where the cylinder retainer is mounted cannot be used for mounting the rotary/lifting module.
- Either a pneumatic standards-based cylinder DSBC or an electric cylinder ESBF can be attached to the cylinder holder. (These cylinders must be ordered separately).

-  - Note

Eccentric loads can destroy the bearing.  
 The front side (V) may be used only to attach a symmetrical applied load.

# Rotary/lifting modules EHMB, electric

Key features

Complete system comprising rotary/lifting module, motor and axial kit  
Rotary/lifting module

→ page 6

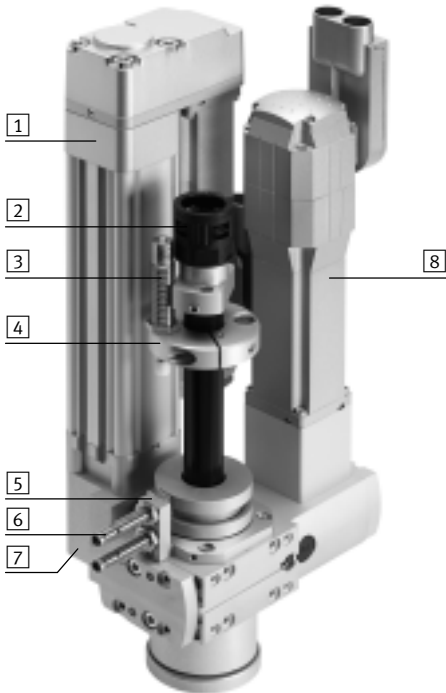

- 1 Electric cylinder ESBF, alternatively standards-based cylinder DSBC<sup>1)</sup>
- 2 Protective conduit fitting<sup>1)</sup>
- 3 Shock absorber<sup>1)</sup>
- 4 Shock absorber retainer<sup>1)</sup>
- 5 Sensor bracket
- 6 Proximity sensor SIEN<sup>1)</sup>
- 7 Cylinder retainer
- 8 Motor for rotation<sup>1)</sup>

1) These parts must be ordered separately as accessories.

## Motors

→ page 17

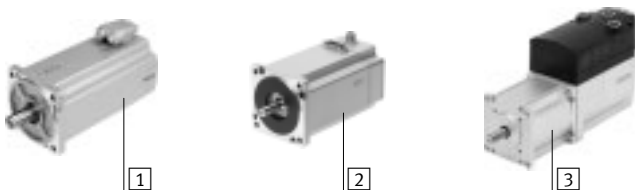

- 1 Servo motor EMME-AS, EMMS-AS
- 2 Stepper motor EMMS-ST
- 3 Integrated drive EMCA

**Note**  
A range of specially matched complete solutions is available for the rotary/lifting module EHMB and motors.

## Motor controller

Technical data → Internet: motor controller

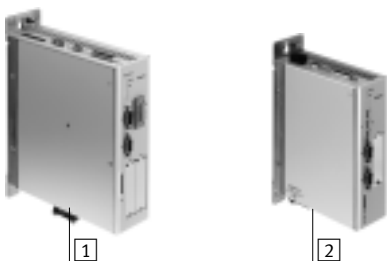

- 1 Servo motor controller CMMP-AS
- 2 Stepper motor controller CMMS-ST

## Motor mounting kit

→ page 17

### Axial kit

### Parallel kit



Complete kits are available for both parallel and axial motor mounting.

# Rotary/lifting modules EHMB, electric

Peripherals overview

## Peripherals overview

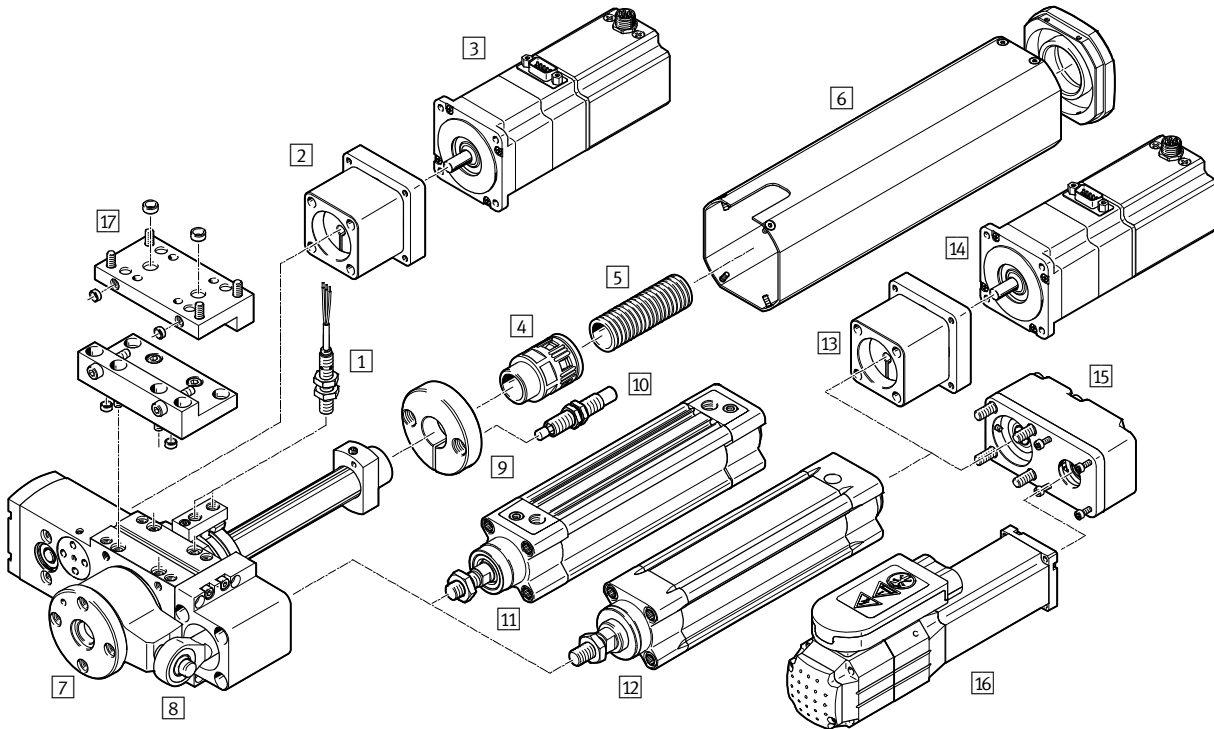

Accessories		
Type	Description	→ Page/Internet
1 Proximity sensor SIEN	<ul style="list-style-type: none"> <li>For use as a signal check and safety check</li> <li>The holder for the proximity sensor SIEN is included in the scope of delivery of the rotary lifting module</li> <li>Two cams → page 23, for sensing positions, are included in the scope of delivery</li> </ul>	23
2 Axial kit EAMM-A	<ul style="list-style-type: none"> <li>For the rotation of the rotary/lifting module</li> <li>For axial motor mounting</li> <li>(consisting of: coupling, coupling housing and motor flange)</li> </ul>	17
3 Motor EMMS, EMME, EMCA	<ul style="list-style-type: none"> <li>For the rotation of the rotary/lifting module</li> <li>Motors specially matched to the axis, with or without brake</li> <li>The motor can be mounted turned by 90° depending on the requirement. This means the connection side can be freely selected</li> </ul>	17
4 Protective conduit fitting EASA	For attaching the protective conduit	23
5 Protective conduit MKR	For protecting electrical cables and compressed air tubing	23
6 Cover EASC	<ul style="list-style-type: none"> <li>For protecting the grooved shaft guide and the trip cams</li> <li>Cannot be used in conjunction with the parallel kit EAMM-U for size 20, 25</li> </ul>	22
7 Rotary/lifting module EHMB	Combination of linear and rotary drive	6
8 Rod eye SGS	<ul style="list-style-type: none"> <li>Connecting piece between rotary/lifting module and standard/electric cylinder</li> <li>Included in the scope of delivery of the rotary lifting module</li> </ul>	22
9 Shock absorber retainer EAYH	Retainer for the shock absorber DYSW	22

# Rotary/lifting modules EHMB, electric

Peripherals overview and type codes

Accessories			
Type	Description	→ Page/Internet	
10 Shock absorber DYSW	Hydraulic shock absorber with path-controlled flow control function	22	
11 Standards-based cylinder DSBC	Pneumatic drive for the linear motion of the rotary/lifting module	16	
12 Electric cylinders ESBF	Electric drive for the linear motion of the rotary/lifting module	16	
13 Axial kit EAMM-A	<ul style="list-style-type: none"> <li>For the linear motion of the rotary/lifting module</li> <li>For axial motor mounting</li> <li>Alternative parallel kit 15</li> <li>(consisting of: coupling, coupling housing and motor flange)</li> </ul>	esbf	
14 Motor EMMS, EMME, EMCA	<ul style="list-style-type: none"> <li>For the linear motion of the rotary/lifting module</li> <li>Motors specially matched to the axis, with or without brake</li> <li>The motor can be mounted turned by 90° depending on the requirement. This means the connection side can be freely selected</li> </ul>	esbf	
15 Parallel kit EAMM-U	<ul style="list-style-type: none"> <li>For the linear motion of the rotary/lifting module</li> <li>For parallel motor mounting</li> <li>Alternative axial kit 13</li> <li>(consisting of: housing, clamping component, clamping sleeve, toothed belt pulley, toothed belt)</li> </ul>	esbf	
16 Motor EMMS, EMME, EMCA	<ul style="list-style-type: none"> <li>For the linear motion of the rotary/lifting module</li> <li>Motors specially matched to the axis, with or without brake</li> <li>The motor can be mounted turned by 90° depending on the requirement. This means the connection side can be freely selected</li> </ul>	esbf	
17 Adapter plate kit EHAM	<ul style="list-style-type: none"> <li>For attaching the EHMB to the axes EGC and DGC</li> <li>Screws and centring sleeves are included in the scope of delivery of the adapter plate kit</li> </ul>	22	
– Adapters	For drive/drive connections	24	
	For drive/gripper connections	gripper	

 Note

When laying electrical cables or compressed air tubing through the hollow shaft of the grooved guide, the rotation angle of the EHMB must be limited to a rotation angle appropriate to the cables or compressed air tubing. Endless rotation damages cables and tubes.

## Type codes

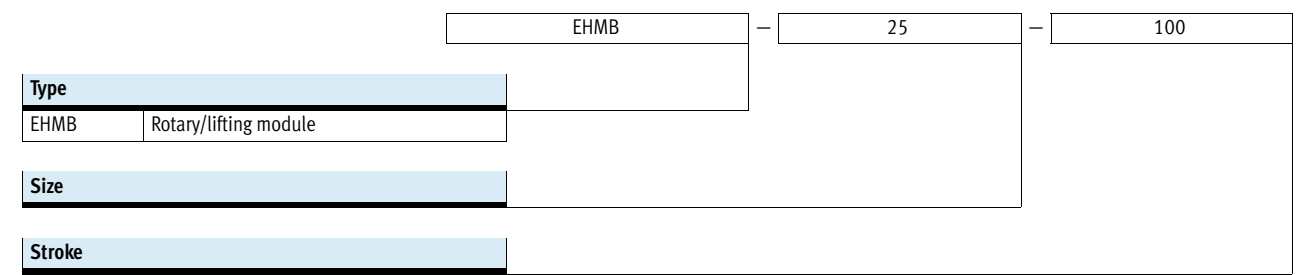

# Rotary/lifting modules EHMB, electric

Technical data

Size  
20, 25, 32

Note  
All values are based on a room temperature of 23 °C.



General technical data				
Size		20	25	32
Design		Electromechanical rotary/lifting module with toothed belt		
Drive pinion $\varnothing$	[mm]	6	8	12
Rotation angle		Infinite (→ page 5)		
Stroke, linear	[mm]	100, 200		
Repetition accuracy, rotary <sup>1)</sup>				
With servo motor EMMS-AS	[°]	±0.03		
With stepper motor EMMS-ST <sup>2)</sup>	[°]	±0.08		
With integrated drive EMCA	[°]	±0.05		
Max. speed, linear				
With standards-based cylinder DSBC	[m/s]	→ page 10		
With electric cylinder ESBF	[m/s]	1.1		1.2
Positioning times, rotary				
→ page 11				
Gear ratio		4.5:1	4:1	3:1
Position sensing		Via proximity sensor		
Mounting position		Any		

- 1) When the travel profile remains the same. The specifications apply only when the motor is directly mounted. If a gearbox is also installed, the repetition accuracy will be different  
2) Dependent on the encoder resolution.

Note  
The connection between the drive and the EHMB for linear motion is not backlash-free.

Mechanical data				
Size		20	25	32
Max. driving torque	[Nm]	0.7	2.2	6.7
Max. output torque <sup>1)</sup>	[Nm]	3.15	8.8	20
Average no-load driving torque <sup>2)</sup>	[Nm]	< 0.07	< 0.18	< 0.5
Max. input speed	[rpm]	1350	1200	900
Max. output speed	[rpm]	300	300	300
Max. payload, horizontal	[kg]	3	5	8
Max. payload, vertical	[kg]	3	5	15 <sup>3)</sup>
Toothed belt pitch		2	3	5

- 1) Output torque minus friction is dependent on speed.  
2) At maximum rotational speed.  
3) With symmetrical and non-eccentric arrangement.

# Rotary/lifting modules EHMB, electric

Technical data

Mechanical data				
Size		20	25	32
Max. mass moment of inertia <sup>1)</sup>	[kgcm <sup>2</sup> ]	1000	5000	10000
Max. inertia factor <sup>2)</sup>				
	for servo motor EMMS-AS/EMME-AS	45		
	for stepper motor EMMS-ST	30		
	for integrated drive EMCA	16		

1) These values specify the upper limit independently of what is determined using the inertia factor.

2) The inertia factor represents the maximum controllable ratio between the inertia of the load and the intrinsic inertia of the motor with brake.

Example:

Rotary/lifting module EHMB-20 → transmission ratio  $i = 4.5$

Motor EMME-AS-40-S with brake → intrinsic inertia  $0.055 \text{ kgcm}^2$

Gearbox EMGA-40-P-G3-40 → transmission ratio  $i = 3$

Limit for the inertia of the load (+ intrinsic inertia) on the output side:

$$0.055 \text{ kgcm}^2 \times 45 \times 3^2 \times 4.5^2 = 451 \text{ kgcm}^2$$

Operating and environmental conditions				
Size		20	25	32
Ambient temperature	[°C]	-10 ... +60		
Noise level $L_{pAeq}$ with cover	[dB (A)]	57	56	53
Noise level $L_{pAeq}$ without cover	[dB (A)]	54	51	51

Weight [g]							
Size	20		25		32		
Stroke	[mm]	100	200	100	200	100	200
Product weight							
Total		1716	1851	3347	3620	6112	6388
Moving load for linear motion							
Guide rod		501	681	1251	1651	1332	1732
Stop nut		25	25	53	53	53	53
Shock absorber retainer		64	64	99	99	99	99
Shock absorber		42	42	66	66	66	66
Rod eye		73	73	73	73	108	108
Moving mass of standards-based cylinder DSBC		200	290	200	290	365	525

## Materials

Sectional view

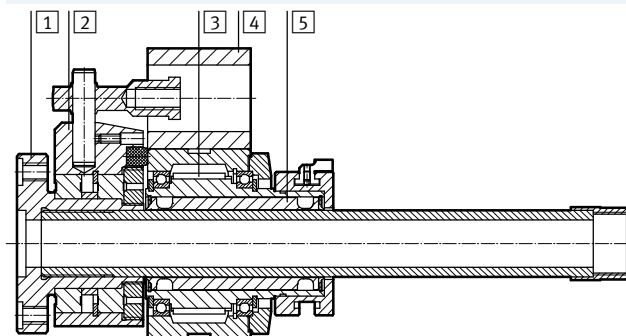

Rotary/lifting module		
1	Flange	Anodised aluminium
2	Mounting	Anodised wrought aluminium alloy
3	Toothed belt	Polychloroprene with glass fibre
4	Holder	Anodised aluminium
5	Drive shaft	Steel
-	Drive shaft	High-alloy stainless steel
-	Note on materials	RoHS compliant
-		Contains paint-wetting impairment substances

# Rotary/lifting modules EHMB, electric

Technical data

## Maximum radial and axial force $F_y/F_z$ at the output shaft as a function of distance $x/z$

If the rotary module is subjected to two or more forces at once, the following equation must be satisfied in addition to the maximum loads indicated below.

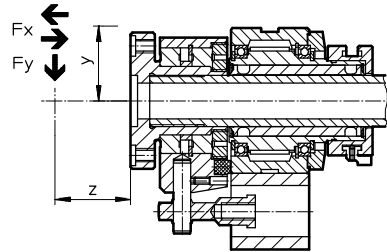

$$\frac{|F_x|}{F_{x_{max}}} + \frac{|F_y|}{F_{y_{max}}} + \frac{|F_z|}{F_{z_{max}}} \leq 1$$

### Max. radial force $F_y$ , dynamic

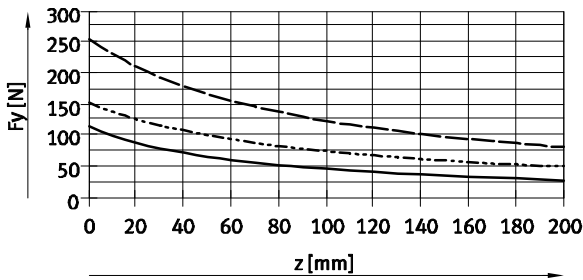

### Max. axial force $F_x$ , dynamic, pushing and pulling

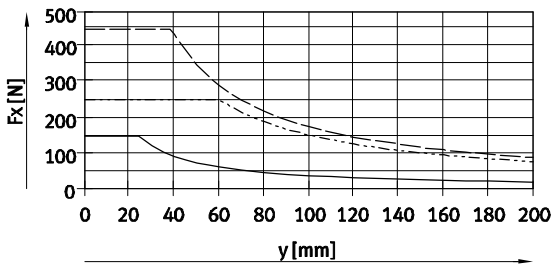

- EHMB-20
- - - EHMB-25
- · - EHMB-32



# Rotary/lifting modules EHMB, electric

Technical data

## Deflection $f$ as a function of lateral stroke $F$ and stroke $l$

The following graphs show the deflection  $f$  of the rotary/lifting module under radial forces and with two strokes.

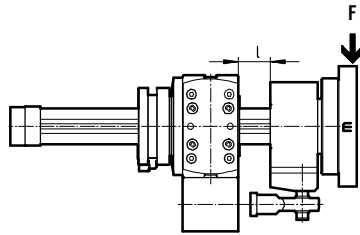

EHMB-20

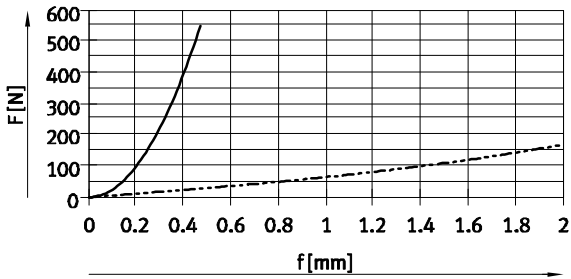

EHMB-25

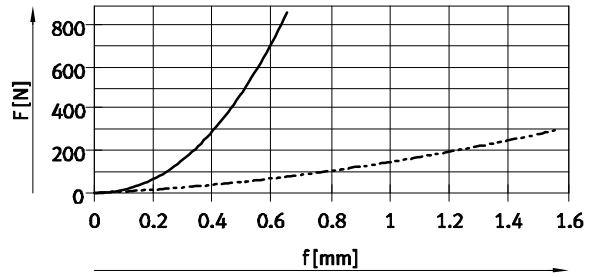

EHMB-32

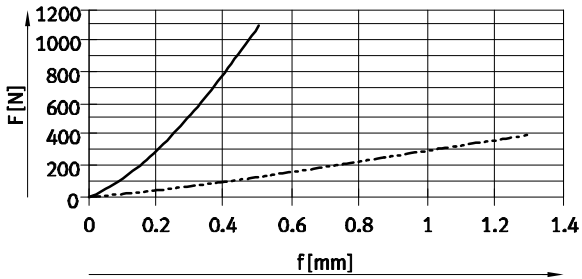

—  $l = 10$  mm  
 - - -  $l = 200$  mm

# Rotary/lifting modules EHMB, electric

Technical data

Max. speed  $v$  as a function of the payload  $m$  in conjunction with the pneumatic standards-based cylinder DSBC

Mounting position:

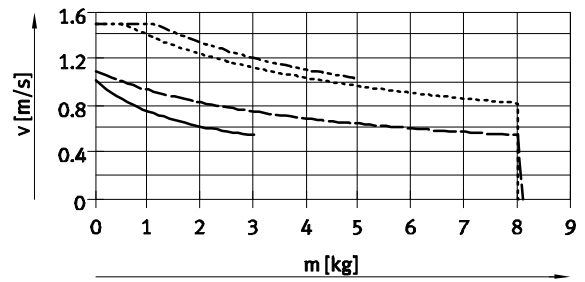
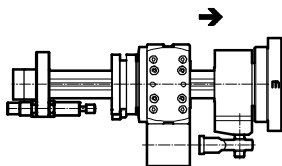
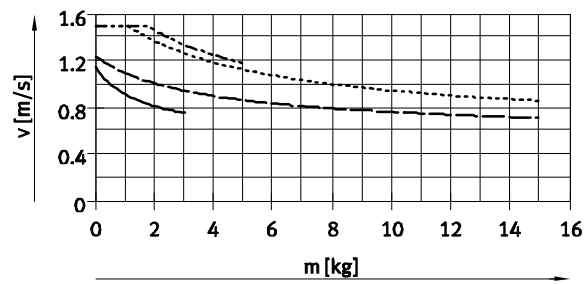
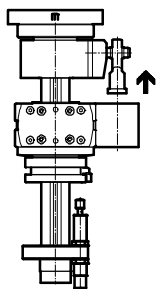
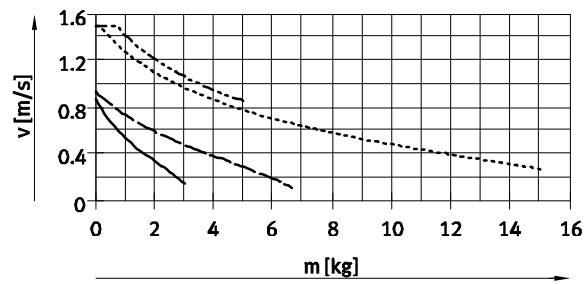
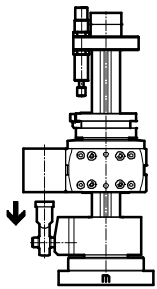

- EHMB-20
- - - EHMB-25
- · - · EHMB-32, with one shock absorber DYSW
- · · · EHMB-32, with two shock absorbers DYSW

# Rotary/lifting modules EHMB, electric

Technical data

## Positioning time $t$ as a function of the rotation angle $\alpha$

Size: 20

Example with servo motor EMMS-AS

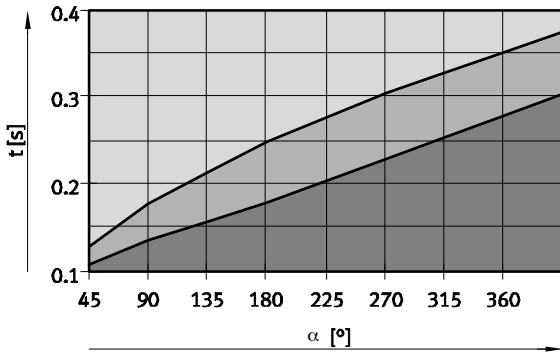

- Permissible range
- The viability is dependent on the motor size and inertia of the load
- Non-implementable range

## Example with stepper motor EMMS-ST

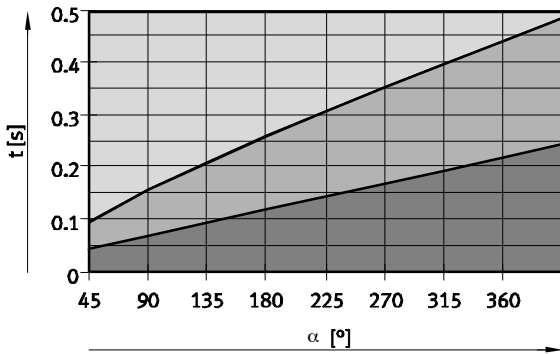

- Permissible range
- The viability is dependent on the motor size and inertia of the load
- Non-implementable range

### Note

The following tool is available for sizing:

Engineering software

PositioningDrives

→ [www.festo.com](http://www.festo.com)

# Rotary/lifting modules EHMB, electric

Technical data

## Positioning time $t$ as a function of the rotation angle $\alpha$

Size: 25

Example with servo motor EMMS-AS

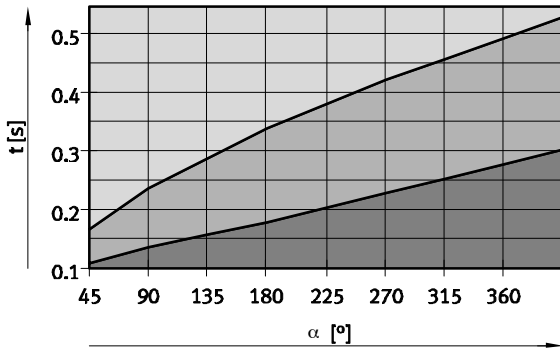

- Permissible range
- The viability is dependent on the motor size and inertia of the load
- Non-implementable range

## Example with stepper motor EMMS-ST

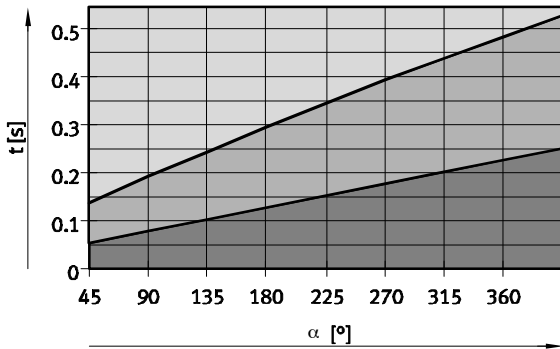

- Permissible range
- The viability is dependent on the motor size and inertia of the load
- Non-implementable range

Note

The following tool is available for sizing:  
 Engineering software  
 PositioningDrives  
[→ www.festo.com](http://www.festo.com)

# Rotary/lifting modules EHMB, electric

Technical data

## Positioning time $t$ as a function of the rotation angle $\alpha$

Size: 32

Example with servo motor EMMS-AS

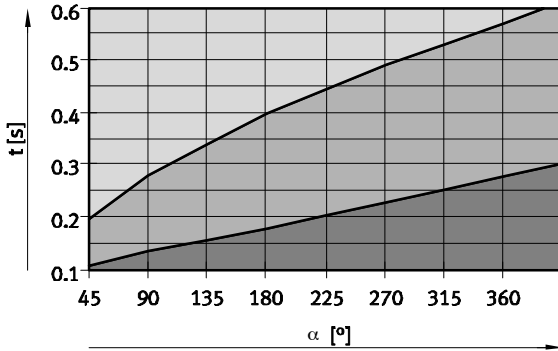

- Permissible range
- The viability is dependent on the motor size and inertia of the load
- Non-implementable range

Example with stepper motor EMMS-ST

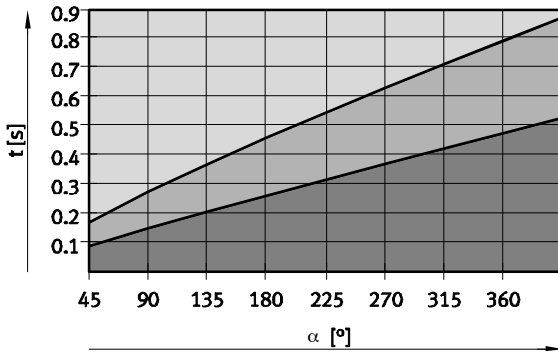

- Permissible range
- The viability is dependent on the motor size and inertia of the load
- Non-implementable range

Note

The following tool is available for sizing:

Engineering software

PositioningDrives

→ [www.festo.com](http://www.festo.com)

# Rotary/lifting modules EHMB, electric

Technical data

FESTO

## Dimensions

Download CAD data → [www.festo.com](http://www.festo.com)

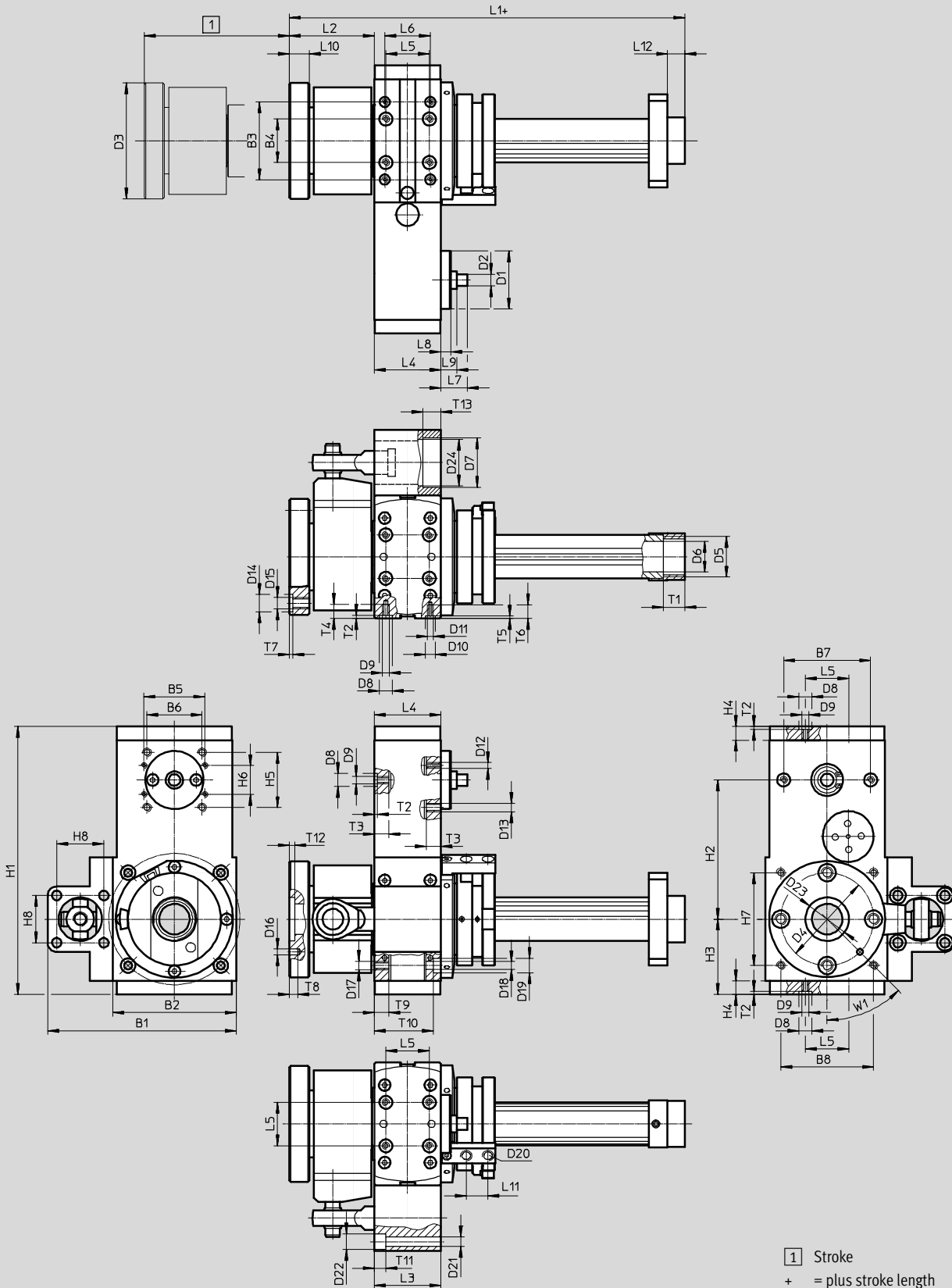

# Rotary/lifting modules EHMB, electric

Technical data

Size	B1 ±0.5	B2 ±0.2	B3 <sup>1)</sup>	B4 <sup>1)</sup>	B5 ±0.15	B6 ±0.15	B7 <sup>1)</sup>	B8 ±0.15	D1 ∅ g7	D2 ∅ H6	D3 ∅	D4 ∅ ±0.05
20	110	65	54	34	32	32.5	30	52	32	6	58	45
25	130	85	53.5	30	42	38	60	64	40	8	80	64
32	169.5	115	70	40	62	56.5	80	88	60	12	80	64

Size	D5	D6 ∅	D7 ∅ H8	D8 ∅ H7	D9	D10 ∅ H7	D11	D12	D13	D14 ∅ H7	D15	D16 ∅ H7	D17
20	Pg16	14	34/30 <sup>2)</sup>	9	M5	7	M4	M3	M6	9	M6	4	M5
25	Pg21	21	34/30 <sup>2)</sup>	9	M5	7	M4	M4	M6	12	M8	4	M6
32	Pg21	21	39/35 <sup>2)</sup>	9	M5	–	M5	M5	M8	12	M8	4	M6

Size	D18 ∅	D19 ∅	D20	D21 ∅	D22 ∅	D23 ∅	D24 ∅	H1 ±0.5	H2 ±0.05	H3	H4	H5 ±0.15	H6 ±0.15
20	–	–	M8x1	6.6	11	19 <sup>H8</sup>	32	149	72	45	9.5	32.5	19
25	5.5	10	M8x1	6.6	11	30 <sup>H7</sup>	32	185	96	52	9.5	38	20
32	6.2	10	M8x1	6.6	11	30 <sup>H7</sup>	37	229.5	108	70.5	13	56.5	31

Size	H7 ±0.15	H8	L1	L2 Min.	L3 ±0.1	L4 ±0.1	L5 <sup>1)</sup>	L6 <sup>1)</sup>	L7	L8	L9	L10	L11 ±0.1	L12
20	44	32.5	147.5	40.5	52	40	30	30	15.8	5	7.8	9	15	12
25	64	32.5	173	58.6	46	46	30	31.5	18.35	7	–	14	15	12
32	88	38	183	61.4	60	60	40	47	23.3	6	–	14	15	12

Size	T1	T2 +0.1	T3	T4	T5 +0.2	T6	T7 +0.1	T8	T9	T10 ±0.2	T11	T12 ±0.5	T13 +0.4	W1
20	14	2.1	10	9	1.6	9.5	2.1	6	8.5	–	11	3	12.5	45°
25	15	2.1	10	9.6	1.6	9.5	2.7	6	10	40.8	8	4	12.5	45°
32	15	2.1	10	9	–	9.5	2.7	6	10	54.3	15	4	14.5	45°

1) Tolerance for centring hole ±0.02 mm.  
Tolerance for thread ±0.1 mm.

 Note  
2) Using a centring ring, the diameter can be reduced (included in the scope of delivery of EHMB).

# Rotary/lifting modules EHMB, electric

Technical data

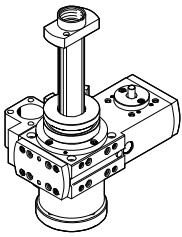
Ordering data				
	Size	Stroke [mm]	Part No.	Type
	20	100	<b>1107096</b>	<b>EHMB-20-100</b>
		200	<b>1107097</b>	<b>EHMB-20-200</b>
	25	100	<b>1095933</b>	<b>EHMB-25-100</b>
		200	<b>1095934</b>	<b>EHMB-25-200</b>
	32	100	<b>1098558</b>	<b>EHMB-32-100</b>
		200	<b>1098559</b>	<b>EHMB-32-200</b>

## Cylinder connection for linear motion

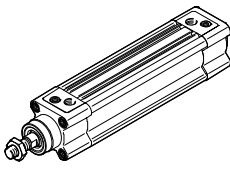
Ordering data			
In conjunction with the pneumatic standards-based cylinder DSBC			Technical data → Internet: dsbc
	For rotary/lifting module	Standards-based cylinder DSBC	
		Part No.	Type
	EHMB-20-100	<b>1376426</b>	<b>DSBC-32-100-PPVA-N3</b>
	EHMB-20-200	<b>1376429</b>	<b>DSBC-32-200-PPVA-N3</b>
	EHMB-25-100	<b>1376426</b>	<b>DSBC-32-100-PPVA-N3</b>
	EHMB-25-200	<b>1376429</b>	<b>DSBC-32-200-PPVA-N3</b>
	EHMB-32-100	<b>1376660</b>	<b>DSBC-40-100-PPVA-N3</b>
	EHMB-32-200	<b>1376663</b>	<b>DSBC-40-200-PPVA-N3</b>

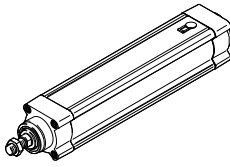
In conjunction with electric cylinder ESBF			
			Technical data → Internet: esbf
	For rotary/lifting module	Electric cylinder ESBF	
		Part No.	Type
	EHMB-20-100	<b>1)</b>	<b>ESBF-...-32-100-...</b>
	EHMB-20-200	<b>1)</b>	<b>ESBF-...-32-200-...</b>
	EHMB-25-100	<b>1)</b>	<b>ESBF-...-32-100-...</b>
	EHMB-25-200	<b>1)</b>	<b>ESBF-...-32-200-...</b>
	EHMB-32-100	<b>1)</b>	<b>ESBF-...-40-100-...</b>
	EHMB-32-200	<b>1)</b>	<b>ESBF-...-40-200-...</b>

1) Ordering data → Internet: esbf





# Rotary/lifting modules EHMB, electric

Accessories

FESTO

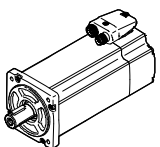
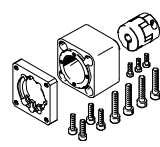
## Motor mounting for rotary motion

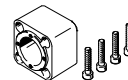
Permissible axis/motor combinations with axial kit – Without gearbox				Technical data → Internet: eamm-a
Motor <sup>1)</sup>	Axial kit	Axial kit comprises:		
		Motor flange	Coupling	Coupling housing
				
Type	Part No. Type	Part No. Type	Part No. Type	Part No. Type
<b>EHMB-20</b>				
With servo motor				
EMME-AS-40-...	2207441 EAMM-A-D32-35A-40P	–	533708 EAMC-30-32-6-8	2207509 EAMK-A-D32-35-40P
EMMS-AS-40-...	560281 EAMM-A-D32-35A-40A	–	558312 EAMC-30-32-6-6	560280 EAMK-A-D32-35-40A
EMMS-AS-55-...	550979 EAMM-A-D32-55A	529942 EAMF-A-44A/B-55A	551003 EAMC-30-32-6-9	551006 EAMK-A-D32-44A/C
EMME-AS-60-...	1956054 EAMM-A-D32-60P	1956846 EAMF-A-44C-60P	1233256 EAMC-30-32-6-14	551006 EAMK-A-D32-44A/C
With stepper motor				
EMMS-ST-42-...	543148 EAMM-A-D32-42A	552164 EAMF-A-28B-42A	543419 EAMC-16-20-5-6	552155 EAMK-A-D32-28B
EMMS-ST-57-...	550980 EAMM-A-D32-57A	530081 EAMF-A-44A/B-57A	551002 EAMC-30-32-6-6.35	551006 EAMK-A-D32-44A/C
With integrated drive				
EMCA-EC-67-...	1454239 EAMM-A-D32-67A	1476305 EAMF-A-44A/B/C-67A-S1	551003 EAMC-30-32-6-9	551006 EAMK-A-D32-44A/C
<b>EHMB-25</b>				
With servo motor				
EMMS-AS-55-...	543153 EAMM-A-D40-55A	529942 EAMF-A-44A/B-55A	543423 EAMC-30-32-8-9	552157 EAMK-A-D40-44A/C
EMME-AS-60-...	1977000 EAMM-A-D40-60P	1956846 EAMF-A-44C-60P	562682 EAMC-30-32-8-14	552157 EAMK-A-D40-44A/C
EMMS-AS-70-...	550981 EAMM-A-D40-70A	529943 EAMF-A-44A/B-70A	551004 EAMC-30-32-8-11	552157 EAMK-A-D40-44A/C
With stepper motor				
EMMS-ST-57-...	543154 EAMM-A-D40-57A	530081 EAMF-A-44A/B-57A	543421 EAMC-30-32-6.35-8	552157 EAMK-A-D40-44A/C
EMMS-ST-87-...	550982 EAMM-A-D40-87A	530082 EAMF-A-44A/B-87A	551004 EAMC-30-32-8-11	552157 EAMK-A-D40-44A/C
With integrated drive				
EMCA-EC-67-...	1454243 EAMM-A-D40-67A	1476305 EAMF-A-44A/B/C-67A-S1	543423 EAMC-30-32-8-9	552157 EAMK-A-D40-44A/C

1) The input torque must not exceed the maximum permissible transferable torque of the axial kit.

 Note

Note the maximum permissible driving torque of the EHMB. The motor current may need to be limited.



The following tool is available for sizing:  
Engineering software  
PositioningDrives  
→ [www.festo.com](http://www.festo.com)

# Rotary/lifting modules EHMB, electric

Accessories

FESTO

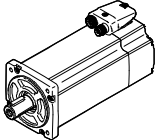
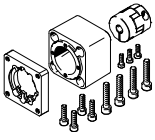
## Motor mounting for rotary motion

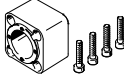
Permissible axis/motor combinations with axial kit – Without gearbox					Technical data → Internet: eamm-a
Motor <sup>1)</sup>	Axial kit	Axial kit comprises:			
		Motor flange	Coupling	Coupling housing	
					
Type	Part No. Type	Part No. Type	Part No. Type	Part No. Type	
<b>EHMB-32</b>					
With servo motor					
EMMS-AS-70-...	543161 EAMM-A-D60-70A	529945 EAMF-A-64A/B-70A	543424 EAMC-42-50-11-12	552160 EAMK-A-D60-64B	
EMME-AS-80-...	1977073 EAMM-A-D60-80P	1977113 EAMF-A-64A/C-80P	551005 EAMC-42-50-12-19	551007 EAMK-A-D60-64C	
EMME-AS-100-...	550983 EAMM-A-D60-100A	529947 EAMF-A-64A/C/D-100A	551005 EAMC-42-50-12-19	551007 EAMK-A-D60-64C	
EMMS-AS-100-...	550983 EAMM-A-D60-100A	529947 EAMF-A-64A/C/D-100A	551005 EAMC-42-50-12-19	551007 EAMK-A-D60-64C	
With stepper motor					
EMMS-ST-87-...	543162 EAMM-A-D60-87A	533140 EAMF-A-64A/B-87A	543424 EAMC-42-50-11-12	552160 EAMK-A-D60-64B	

1) The input torque must not exceed the maximum permissible transferable torque of the axial kit.

-  - Note

Note the maximum permissible driving torque of the EHMB. The motor current may need to be limited.



The following tool is available for sizing:  
Engineering software  
PositioningDrives  
→ [www.festo.com](http://www.festo.com)

# Rotary/lifting modules EHMB, electric

Accessories

FESTO

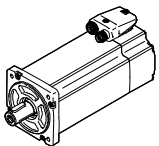
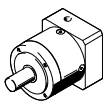
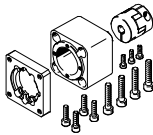
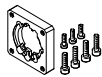
## Motor mounting for rotary drive

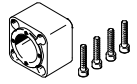
Permissible axis/motor combinations with axial kit – With gearbox				Technical data → Internet: eamm-a	
Motor <sup>1)</sup>	Gear units	Axial kit	Axial kit comprises:		
			Motor flange	Coupling	Coupling housing
					
Type	Type	Part No. Type	Part No. Type	Part No. Type	Part No. Type
<b>EHMB-20</b>					
With servo motor					
EMME-AS-40-...	EMGA-40-P-G...-EAS-40	1454238 EAMM-A-D32-40G	1460095 EAMF-A-44C-40G-S1	562681 EAMC-30-32-6-10	551006 EAMK-A-D32-44A/C
EMMS-AS-40-...	EMGA-40-P-G...-SAS-40	1454238 EAMM-A-D32-40G	1460095 EAMF-A-44C-40G-S1	562681 EAMC-30-32-6-10	551006 EAMK-A-D32-44A/C
EMMS-AS-55-...	EMGA-60-P-G...-SAS-55	2946758 EAMM-A-D32-60G	1460105 EAMF-A-44C-60G/H-S1	3187577 EAMC-30-32-6-11	551006 EAMK-A-D32-44A/C
EMME-AS-60-...	EMGA-60-P-G...-EAS-60	2946760 EAMM-A-D32-60H	1460105 EAMF-A-44C-60G/H-S1	1233256 EAMC-30-32-6-14	551006 EAMK-A-D32-44A/C
EMMS-AS-70-...	EMGA-60-P-G...-SAS-70	2946758 EAMM-A-D32-60G	1460105 EAMF-A-44C-60G/H-S1	3187577 EAMC-30-32-6-11	551006 EAMK-A-D32-44A/C
With stepper motor					
EMMS-ST-42-...	EMGA-40-P-G...-SST-42	1454238 EAMM-A-D32-40G	1460095 EAMF-A-44C-40G-S1	562681 EAMC-30-32-6-10	551006 EAMK-A-D32-44A/C
EMMS-ST-57-...	EMGA-60-P-G...-SST-57	2946758 EAMM-A-D32-60G	1460105 EAMF-A-44C-60G/H-S1	3187577 EAMC-30-32-6-11	551006 EAMK-A-D32-44A/C
With integrated drive					
EMCA-EC-67-...	EMGC-40-...	1454238 EAMM-A-D32-40G	1460095 EAMF-A-44C-40G-S	562681 EAMC-30-32-6-10	551006 EAMK-A-D32-44A/C
	EMGC-60-...	2946760 EAMM-A-D32-60H	1460105 EAMF-A-44C-60G/H-S1	1233256 EAMC-30-32-6-14	551006 EAMK-A-D32-44A/C



1) The input torque must not exceed the maximum permissible transferable torque of the axial kit.

# Rotary/lifting modules EHMB, electric

Accessories

FESTO

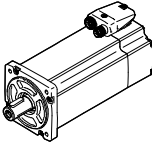
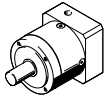
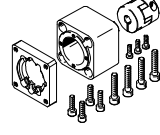
## Motor mounting for rotary drive

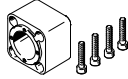
Permissible axis/motor combinations with axial kit – With gearbox						Technical data → Internet: eamm-a
Motor <sup>1)</sup>	Gear units	Axial kit	Axial kit comprises:			
			Motor flange	Coupling	Coupling housing	
						
Type	Type	Part No. Type	Part No. Type	Part No. Type	Part No. Type	
<b>EHMB-25</b>						
With servo motor						
EMME-AS-40-...	EMGA-40-P-G...-EAS-40	560282	550986	558029	552157	
		EAMM-A-D40-40G	EAMF-A-44A/B-40G	EAMC-30-32-8-10	EAMK-A-D40-44A/C	
		2256398	1460095	558029	552157	
EMMS-AS-40-...	EMGA-40-P-G...-SAS-40	EAMM-A-D40-40G-G2 <sup>2)</sup>	EAMF-A-44C-40G-S1	EAMC-30-32-8-10	EAMK-A-D40-44A/C	
		560282	550986	558029	552157	
		EAMM-A-D40-40G	EAMF-A-44A/B-40G	EAMC-30-32-8-10	EAMK-A-D40-44A/C	
EMMS-AS-55-...	EMGA-60-P-G...-SAS-55	2256400	1460105	551004	552157	
		EAMM-A-D40-60G	EAMF-A-44C-60G/H-S1	EAMC-30-32-8-11	EAMK-A-D40-44A/C	
		560282	550986	558029	552157	
EMME-AS-60-...	EMGA-60-P-G...-EAS-60	EAMM-A-D40-60G-G2 <sup>2)</sup>	EAMF-A-44C-60G/H-S1	EAMC-30-32-8-14	EAMK-A-D40-44A/C	
		1454242	1460105	562682	552157	
		EAMM-A-D40-60H	EAMF-A-44C-60G/H-S1	EAMC-30-32-8-14	EAMK-A-D40-44A/C	
EMMS-AS-70-...	EMGA-60-P-G...-SAS-70	2256400	1460105	551004	552157	
		EAMM-A-D40-60G	EAMF-A-44C-60G/H-S1	EAMC-30-32-8-11	EAMK-A-D40-44A/C	
		560282	550986	558029	552157	
EMMS-ST-42-...	EMGA-40-P-G...-SST-42	EAMM-A-D40-40G	EAMF-A-44A/B-40G	EAMC-30-32-8-10	EAMK-A-D40-44A/C	
		560282	550986	558029	552157	
		2256400	1460105	551004	552157	
EMMS-ST-57-...	EMGA-60-P-G...-SST-57	EAMM-A-D40-60G	EAMF-A-44C-60G/H-S1	EAMC-30-32-8-11	EAMK-A-D40-44A/C	
		2256400	1460105	551004	552157	
		560282	550986	558029	552157	
With integrated drive						
EMCA-EC-67-...	EMGC-40-...	560282	550986	558029	552157	
		EAMM-A-D40-40G	EAMF-A-44A/B-40G	EAMC-30-32-8-10	EAMK-A-D40-44A/C	
		2256398	1460095	558029	552157	
	EMGC-60-...	EAMM-A-D40-40G-G2 <sup>2)</sup>	EAMF-A-44C-40G-S1	EAMC-30-32-8-10	EAMK-A-D40-44A/C	
		1454242	1460105	562682	552157	
	EAMM-A-D40-60H	EAMF-A-44C-60G/H-S1	EAMC-30-32-8-14	EAMK-A-D40-44A/C		

1) The input torque must not exceed the maximum permissible transferable torque of the axial kit.

2) The axial kit can be retrofitted with a seal set EADS-F to change the degree of protection from IP40 to IP65. Further information → eamm-a

# Rotary/lifting modules EHMB, electric

Accessories



## Motor mounting for rotary drive

Permissible axis/motor combinations with axial kit – With gearbox						Technical data → Internet: eamm-a
Motor <sup>1)</sup>	Gear units	Axial kit	Axial kit comprises:			
			Motor flange	Coupling	Coupling housing	
Type	Type	Part No. Type	Part No. Type	Part No. Type	Part No. Type	
<b>EHMB-32</b>						
With servo motor						
EMMS-AS-55-...	EMGA-60-P-G...-SAS-55	560283 EAMM-A-D60-60G	550987 EAMF-A-64A/B-60G	543424 EAMC-42-50-11-12	552160 EAMK-A-D60-64B	
EMME-AS-60-...	EMGA-60-P-G...-EAS-60	1454245 EAMM-A-D60-60H	2256289 EAMF-A-64B-60G/H-S1	1455671 EAMC-42-50-12-14	552160 EAMK-A-D60-64B	
EMMS-AS-70-...	EMGA-60-P-G...-SAS-70	560283 EAMM-A-D60-60G	550987 EAMF-A-64A/B-60G	543424 EAMC-42-50-11-12	552160 EAMK-A-D60-64B	
		2256696 EAMM-A-D60-60G-G <sup>2)</sup>	2256289 EAMF-A-64B-60G/H-S1	543424 EAMC-42-50-11-12	552160 EAMK-A-D60-64B	
EMMS-AS-70-...	EMGA-80-P-G...-SAS-70	1499402 EAMM-A-D60-80G	2843290 EAMF-A-64C-80G-S1	2138701 EAMC-42-50-12-20	551007 EAMK-A-D60-64C	
EMME-AS-80-...	EMGA-80-P-G...-EAS-80	1499402 EAMM-A-D60-80G	2843290 EAMF-A-64C-80G-S1	2138701 EAMC-42-50-12-20	551007 EAMK-A-D60-64C	
EMME-AS-100-...	EMGA-80-P-G...-SAS-100	1499402 EAMM-A-D60-80G	2843290 EAMF-A-64C-80G-S1	2138701 EAMC-42-50-12-20	551007 EAMK-A-D60-64C	
EMMS-AS-100-...	EMGA-80-P-G...-SAS-100	1499402 EAMM-A-D60-80G	2843290 EAMF-A-64C-80G-S1	2138701 EAMC-42-50-12-20	551007 EAMK-A-D60-64C	
With stepper motor						
EMMS-ST-57-...	EMGA-60-P-G...-SST-57	560283 EAMM-A-D60-60G	550987 EAMF-A-64A/B-60G	543424 EAMC-42-50-11-12	552160 EAMK-A-D60-64B	
		2256696 EAMM-A-D60-60G-G <sup>2)</sup>	2256289 EAMF-A-64B-60G/H-S1	543424 EAMC-42-50-11-12	552160 EAMK-A-D60-64B	
EMMS-ST-87-...	EMGA-80-P-G...-SST-87	1499402 EAMM-A-D60-80G	2843290 EAMF-A-64C-60G-S1	2138701 EAMC-42-50-12-20	551007 EAMK-A-D60-64C	
With integrated drive						
EMCA-EC-67-...	EMGC-60-...	1454245 EAMM-A-D60-60H	2256289 EAMF-A-64B-60G/H-S1	1455671 EAMC-42-50-12-14	552160 EAMK-A-D60-64B	

1) The input torque must not exceed the maximum permissible transferable torque of the axial kit.

2) The axial kit can be retrofitted with a seal set EADS-F to change the degree of protection from IP40 to IP65. Further information → eamm-a

Note

Note the maximum permissible driving torque of the EHMB. The motor current may need to be limited.

The following tool is available for sizing:  
Engineering software  
PositioningDrives  
→ [www.festo.com](http://www.festo.com)

# Rotary/lifting modules EHMB, electric

Accessories

FESTO

## Rod eye SGS

Scope of delivery:

1 rod eye, 1 hex nut to DIN 439

Materials:

Galvanised steel

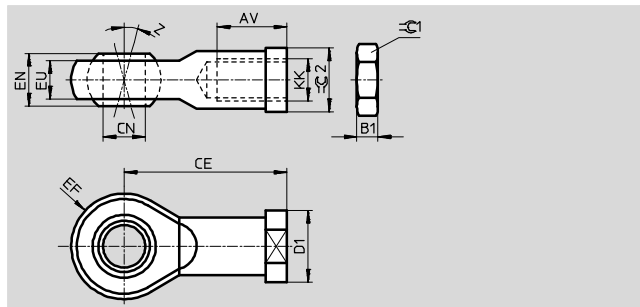

Dimensions and ordering data								
For size	AV	B1	CE	CN Ø H7	D1 Ø	EF ±0.5	EN	EU
20, 25	20 -2	5	43	10	19	14	14	10.5
32	22 -2	6	50	12	22	16	16	12





For size	EU	KK	Z	⌀C1	⌀C2	Part No.	Type
20, 25	10.5	M10x1.25	13	17	17	9261	SGS-M10x1,25
32	12	M12x1.25	13	19	19	9262	SGS-M12x1,25

Ordering data						
	For size	Brief description	Weight [g]	Part No.	Type	PU <sup>1)</sup>
<b>Cover EASC</b>						
	20	<ul style="list-style-type: none"> <li>For protecting the grooved shaft guide</li> <li>Cannot be used in conjunction with parallel kit EAMM-U</li> </ul>	303	1099901	EASC-H1-20-100	1
			388	1099902	EASC-H1-20-200	
	25		385	1096387	EASC-H1-25-100	
			482	1096388	EASC-H1-25-200	
	32		For protecting the grooved shaft guide	383	1107235	
481		1107236	EASC-H1-32-200			
<b>Shock absorber retainer EAYH</b>						
	20	For attaching the shock absorbers	68	1153896	EAYH-H1-20	1
	25, 32		106	1153905	EAYH-H1-25	
<b>Shock absorber DYSW</b>						
	20	Progressive shock absorbers	42	548073	DYSW-8-14-Y1F	1
	25, 32		67	548074	DYSW-10-17-Y1F	
<b>Adapter plate kit EHAM</b>						
	20	For attaching the EHMB to the axes EGC and DGC	288	1132369	EHAM-H1-20-L2-80	1
	25		292	1132402	EHAM-H1-25-L2-80	
	32		668	1132529	EHAM-H1-32-L2-120	

1) Packaging unit

# Rotary/lifting modules EHMB, electric

Accessories

Ordering data						
	For size	Brief description	Weight [g]	Part No.	Type	PU <sup>1)</sup>
Protective conduit fitting EASA						
	20	For attaching the protective conduit	8	1157774	EASA-H1-20-PG16	1
	25, 32		12	1096549	EASA-H1-25-PG21	
Protective conduit MKR						
	20	For protecting lines and tubing	-	177566	MKR-16,5-PG-16	-
	25, 32		-	177567	MKR-23-PG-21	
Cam EAPS						
	20	For sensing positions (2 cams included in the scope of delivery)	11	1234887	EAPS-H1-20-CK	2
	25, 32		11	1234888	EAPS-H1-25-CK	
Centring sleeve						
	- <sup>2)</sup>	For centring loads and attachments	1	186717	ZBH-7	10
			1	150927	ZBH-9	
			1	189653	ZBH-12	

1) Packaging unit

2) Dimensional drawing → page 14

Ordering data – Proximity sensor, inductive				Technical data → Internet: sien	
	Contact	Connection	Part No.	Type	
	N/O contact	Cable, 2.5 m	150386	SIEN-M8B-PS-K-L	
		Plug connector	150387	SIEN-M8B-PS-S-L	
	N/C contact	Cable, 2.5 m	150390	SIEN-M8B-PO-K-L	
		Plug connector	150391	SIEN-M8B-PO-S-L	

-  - Note

The holder for the proximity sensor SIEN is included in the scope of delivery of the rotary/lifting module.

Ordering data – Connecting cables				Technical data → Internet: nebu	
	Electrical connection, left	Electrical connection, right	Cable length [m]	Part No.	Type
	Straight socket, M8x1, 3-pin	Cable, open end,	2.5	541333	NEBU-M8G3-K-2.5-LE3
		3-wire	5	541334	NEBU-M8G3-K-5-LE3

# Rotary/lifting modules EHMB, electric

Accessories



**Adapter kit  
EHAM**

Materials:  
Wrought aluminium alloy  
Free of copper and PTFE  
RoHS compliant

 Note  
The kit includes the individual mounting interface as well as the necessary mounting material.

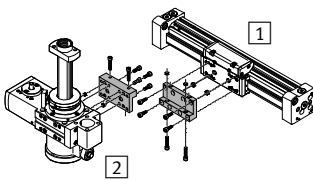
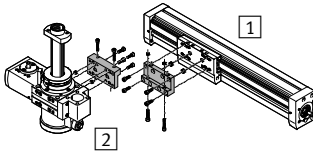
Permissible drive/drive combinations with adapter kit				Download CAD data → <a href="http://www.festo.com">www.festo.com</a>	
Combination	[1] Drive	[2] Drive	Adapter kit		
	Size	Size	CRC <sup>1)</sup>	Part No.	Type
DGC/EHMB	DGC	EHMB	EHAM		
	25	20	2	<b>1132369</b>	<b>EHAM-H1-20-L2-80</b>
	25	25		<b>1132402</b>	<b>EHAM-H1-25-L2-80</b>
	40	32		<b>1132529</b>	<b>EHAM-H1-32-L2-120</b>
EGC/EHMB	EGC	EHMB	EHAM		
	80	20	2	<b>1132369</b>	<b>EHAM-H1-20-L2-80</b>
	80	25		<b>1132402</b>	<b>EHAM-H1-25-L2-80</b>
	120	32		<b>1132529</b>	<b>EHAM-H1-32-L2-120</b>

1) Corrosion resistance class CRC 2 to Festo standard FN 940070  
Moderate corrosion stress. Indoor applications in which condensation may occur. External visible parts with primarily decorative requirements for the surface and which are in direct contact with the ambient atmosphere typical for industrial applications.