

Integrated drives EMCA



Integrated drives EMCA

Key features

At a glance

Integrated drive

- Brushless DC motor (EC motor) for positioning tasks with integrated power and control electronics. This prevents the need for long motor cables, improves the electromagnetic compatibility and reduces the installation time and space requirements
- 64 freely programmable position sets (variables: position, speed or torque)
- Optional: integrated holding brake including holding brake control
- Safety function: “safe torque off” (STO)
- Choice of degree of protection:
 - Standard: IP54 housing and connection technology
 - Optional: IP65 housing and connection technology for increased requirements
- Absolute position sensing via:
 - Standard: singleturn absolute encoder
 - Optional: multiturn absolute displacement encoder with integrated buffer, for saving the position values of movements for up to 7 days (without external power supply). The time can be extended using an external battery box (→ page 19)

Accessories

- Gear unit:
 - Standard: flange-mounted gear unit and angle step (in stock)
 - Special gear unit on request
- Braking resistor:
 - Integrated-chopper braking resistor
 - Optional: external braking resistor (with mounting bracket)
- Pre-assembled cables
- Drive configuration using PositioningDrives
 - Sizing of EMCA and gear unit
 - Braking resistor required: Yes/No
- Commissioning via the Ethernet interface with Festo Configuration Tool (FCT)

The technology in detail



- 1 LED indicators
- 2 Parameterisation interface
Modbus® TCP interface (integrated in EMCA-DIO)
- 3 CANopen interface
PROFINET interface
EtherNet/IP interface
EtherCAT® interface
- 4 Terminal box
- 5 Motor shaft
- 6 Motor flange

Bus protocols

CANopen

PROFINET

EtherNet/IP

EtherCAT

Modbus

Integrated drives EMCA

Key features

Library & tools → www.festo.com/sp/emca (software)

Function elements for simplified programming as well as other software support

- FCT – Festo Configuration Tool – Plug-in for EMCA
- EMCA firmware updates
- CANopen EDS
- EtherNet/IP EDS
- EtherCAT® ESI
- PROFINET GSDML
- Function elements for Festo, Omron, Rockwell Studio 5000, CoDeSys, Beckhoff TwinCAT, Siemens TIA Portal
- Modbus® – Demonstrator

FCT software – Festo Configuration Tool

Software platform for electric drives from Festo (→ www.festo.com/sp/fct)

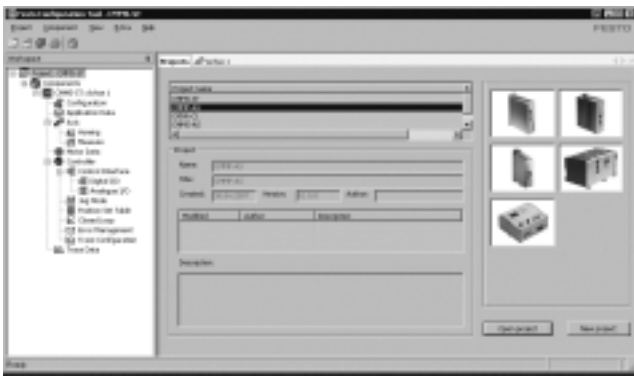

- All drives in a system can be managed and saved in a common project
- Project and data management for all supported types of equipment
- Easy to use thanks to graphically supported parameter entry
- Universal mode of operation for all drives
- Work offline at your desk or online at the machine

FHPP – Festo Handling and Positioning Profile

Optimised data profile

Festo has developed an optimised data profile, the “Festo Handling and Positioning Profile (FHPP)”, which is especially tailored to handling and positioning applications.

With the FHPP data profile, Festo motor controllers can be controlled using a fieldbus interface via standardised control and status bytes.

The following are defined, among others:

- Operating modes
- I/O data structure
- Parameter objects
- Sequence control

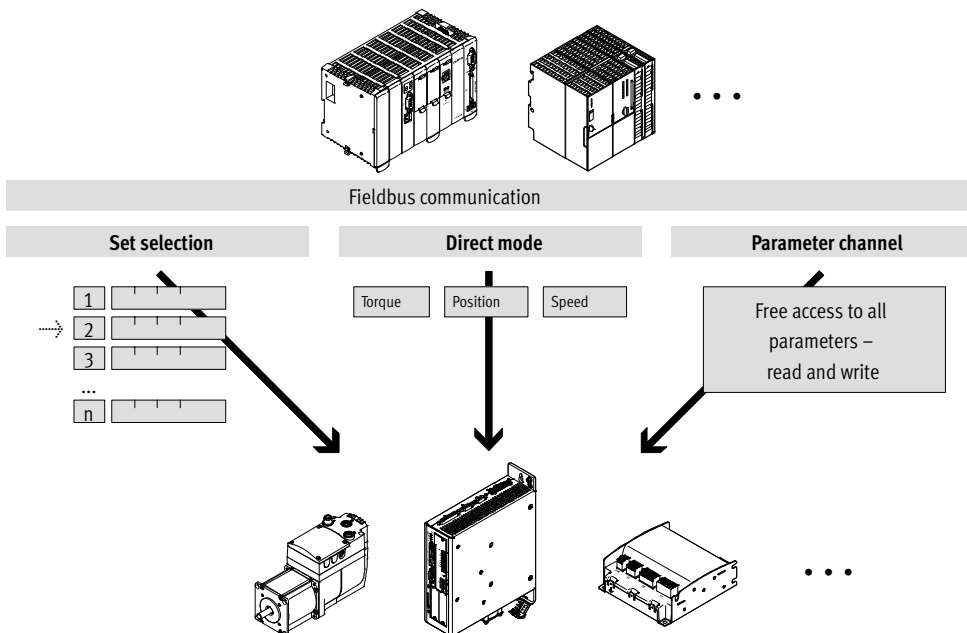

Integrated drives EMCA

Key features

Sample applications

- Printing press and post-pressing machines
- Packaging and labelling machines
- Woodworking machines
- Textile industry
- Medical technology
- Material transport
- Conveying
- Labelling
- Electronics manufacturing

Adjusting sorting conveyors

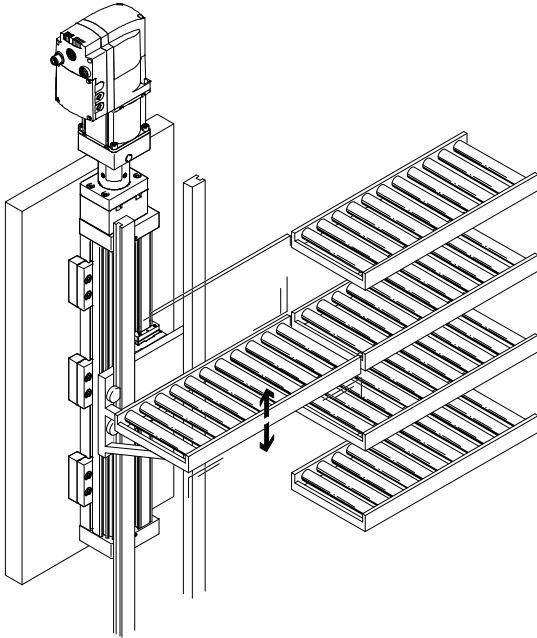

Adjusting formats for paper or foil cutting machines

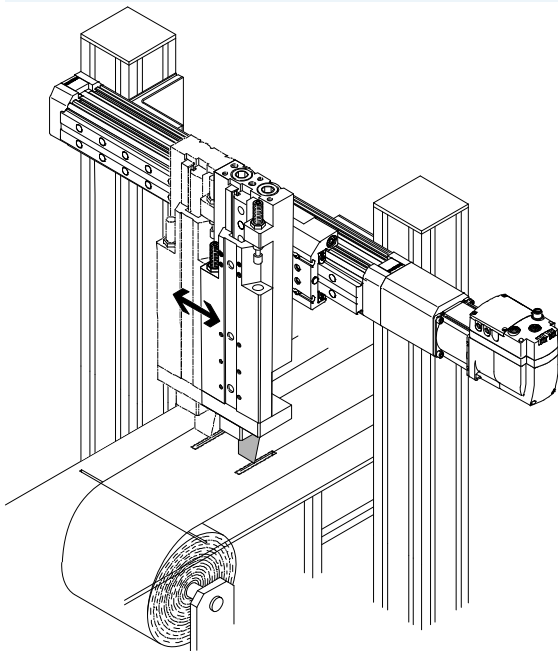

Integrated drives EMCA

Type codes

		EMCA	-	EC	-	67	-	M	-	1		T		E		B	-	CO	-	S1	
Product type																					
EMCA	Motor with controller																				
Motor technology																					
EC	EC motor																				
Motor flange size																					
67	67 mm																				
Length																					
S	Short																				
M	Medium																				
Nominal operating voltage																					
1	24 V DC																				
Electrical connection																					
T	Terminal box																				
Measuring unit																					
E	Absolute encoder, singleturn																				
M	Absolute encoder, multiturn displacement encoder																				
Brake																					
-	None																				
B	With holding brake																				
Bus protocol/control																					
DIO	Digital I/O interface + Modbus® TCP																				
CO	CANopen																				
PN	PROFINET																				
EP	EtherNet/IP																				
EC	EtherCAT®																				
Degree of protection, electrical system																					
-	Standard																				
S1	IP65																				

Integrated drives EMCA

Peripherals overview

Using the variant EMCA-...-CO as an example

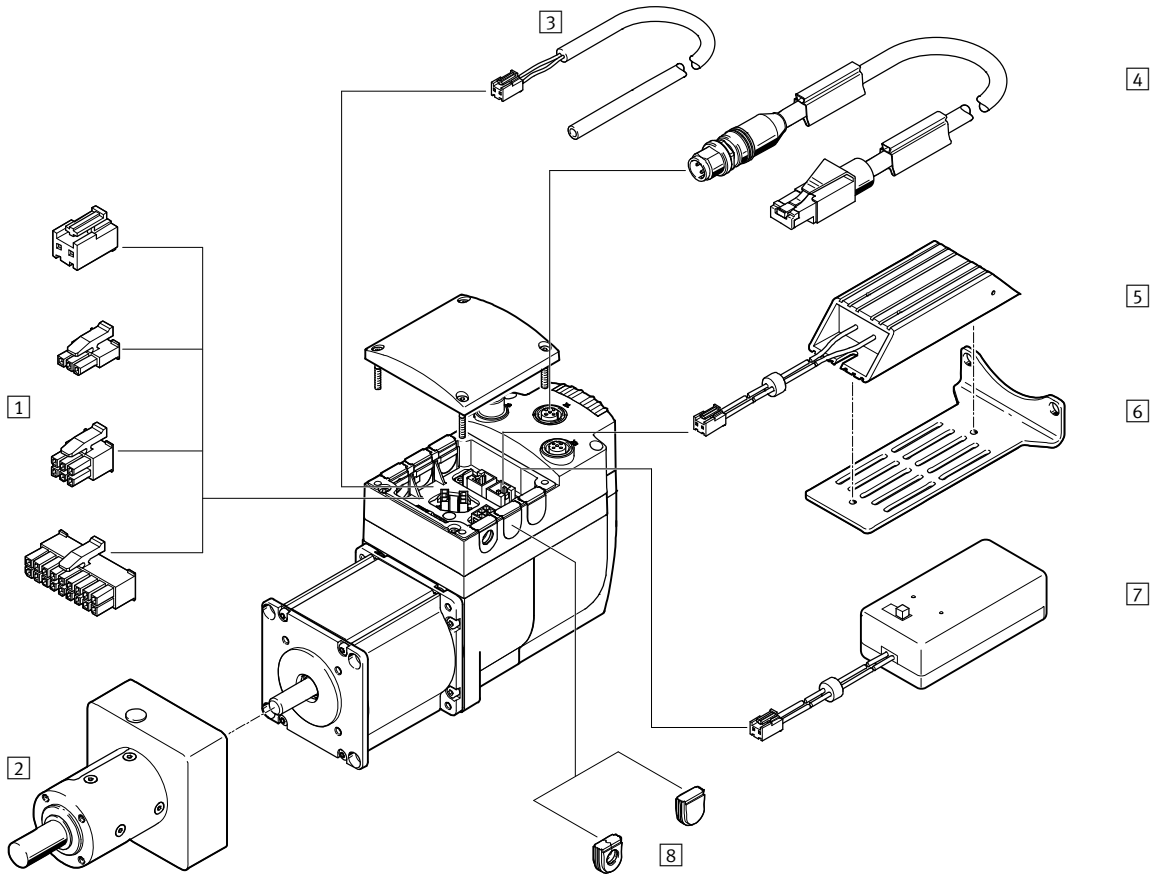

Integrated drives EMCA

Peripherals overview

Accessories		→ Page/Internet	
1	Plug assortment NEKM	<ul style="list-style-type: none"> Connector plugs for power supply, reference/limit switch etc. (for plugs X4, X6, X7, X8, X9 → page 13). Not included in the scope of delivery of the EMCA 	19
2	Gear units EMGC	Increases the torque of the motor, while simultaneously reducing the rotational speed	18
3	Pre-assembled cable NEBM	For power supply, STO interface and I/O interface	20
4	Connecting cable NEBC-D12G4	To parameterise the integrated drive	20
5	Braking resistor CACR-LE2	Absorbs the energy that is supplied back into the intermediate circuit during braking or with external excitation	19
6	Mounting bracket EAHM-M1	For flexible mounting of the braking resistor	19
7	Battery box EADA	To save the position values in combination with the multiturn absolute displacement encoder	19
8	Rubber seals	<ul style="list-style-type: none"> Assortment of seals is included in the scope of delivery of the EMCA Can be ordered using the spare parts catalogue → www.festo.com/emca (documentation) 	emca

Integrated drives EMCA

Technical data

 Size 67

 Voltage
24 V DC

Bus protocols

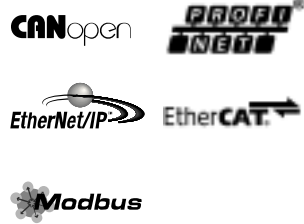

General technical data	
Controller operating mode	PWM MOSFET power output stage Cascade controller with P position controller PI speed controller PI current regulator
Parameterisation interface	Ethernet
Ethernet, supported protocols	TCP/IP
Max. transmission rate [Mbit/s]	100
Rotary position encoder	Absolute encoder, singleturn Absolute encoder, multiturn displacement encoder
Rotary position encoder measuring principle	Magnetic
Resolution	
Singleturn	12 bit (4096 increments per revolution)
Multiturn displacement encoder	12 bit (4096 increments per revolution; ±2,147,483,648 revolutions)
Operating time of multiturn displacement encoder	Without external battery: 7 days With external battery: 6 months
Indicator	LED
Type of mounting	Connecting flange with through-hole
Mounting position	Any

Electrical data		
Size	S	M
Nominal voltage [V DC]	24 ±20%	
Nominal current [A]	6.9	7.2
Peak current [A]	10.2	10.3
Nominal motor power [W]	120	150
Peak motor power [W]	158	200
Max. current, digital outputs [mA]	100	
Switching logic, input/output	PNP	

Technical data, motor		
Size	S	M
Nominal rotary speed [rpm]	3100	3150
Max. rotational speed [rpm]	3500	3300
Nominal torque [Nm]	0.37	0.45
Peak torque [Nm]	0.85	0.91
Mass moment of inertia of rotor [kg cm ²]	0.175	0.301
Permissible shaft load		
Axial [N]	60	
Radial [N]	100	

Integrated drives EMCA

Technical data

Technical data, holding brake		
Holding torque	[Nm]	1
Power consumption	[W]	9
Mass moment of inertia	[kg cm ²]	0.021

Technical data					
Interfaces	I/O	CANopen	PROFINET	EtherNet/IP	EtherCAT®
Number of digital logic outputs	4	2	2	2	2
Number of digital logic inputs	11	2	2	2	2

Technical data – Bus protocol					
Interfaces	Modbus® TCP	CANopen	PROFINET	EtherNet/IP	EtherCAT®
Position sets	64	64	64	64	64
Communication profile	FHPP	CiA 402 and FHPP	FHPP	FHPP	CiA 402 and FHPP
Max. fieldbus transmission rate	[Mbit/s]	100	1	100	100
Terminating resistor	[Ω]	–	120 (can be activated via DIL switch)	–	–
RPI (requested packet interval)	[ms]	–	–	5	–
Transmission services	–	–	–	Messaging: Implicit (T1) Explicit	–

Safety data	
Safety function to EN 61800-5-2	Safe torque off (STO)
Performance level (PL) to EN ISO 13849-1	Category 3, Performance Level d
Safety integrity level (SIL) to EN 61800-5-2	SIL 2
Max. positive test pulse with 0 signal	[μs] 10000
Max. negative test pulse with 1 signal	[μs] 600
Proof test interval	20 years
PFH	1x 10 ⁻⁹
PFD	1.86x 10 ⁻⁵
Diagnostic coverage	[%] 90
Safe failure fraction (SFF)	[%] > 90
Hardware fault tolerance	1
Certificate issuing authority	TÜV 01/205/5514.00/16
CE marking (see declaration of conformity)	To EU EMC Directive ¹⁾
	To EC Machinery Directive
Vibration resistance	Transport application test with severity level 2 to FN 942017-4 and EN 60068-2-6
Shock resistance	Shock test with severity level 2 to FN 942017-5 and EN 60068-2-27

- 1) For information about the applicability of the component see the manufacturer's EC declaration of conformity at: www.festo.com/sp → Certificates.
If the component is subject to restrictions on usage in residential, office or commercial environments or small businesses, further measures to reduce the emitted interference may be necessary.

Weight [g]		
Size	S	M
Product weight	1900	2260
Additional holding brake	350	350
Additional multiturn displacement encoder	25	25

Integrated drives EMCA

Technical data

Operating and environmental conditions	
Characteristics of digital logic outputs	– Freely configurable in some cases – Not galvanically isolated
Characteristics of logic inputs	Galvanically connected to logic potential
Logic input specification	Based on IEC 61131-2
Protective function	i ² t monitoring
	Following error monitoring
	Software end-position detection
	Voltage failure detection
	Current monitoring
Temperature monitoring	
Degree of protection	
EMCA-..., motor shaft	IP54
EMCA-..., motor housing incl. connection technology	IP54
EMCA-...-S1, motor housing incl. connection technology	IP65
Ambient temperature [°C]	0 ... +50
Note on ambient temperature	Power must be reduced by 1.75% per °C at ambient temperatures above 20 °C
Storage temperature [°C]	–25 ... +70
Relative air humidity [%]	0 ... 95 (non-condensing)
Corrosion resistance class CRC ¹⁾	1
Certification	RCM compliance mark
CE marking (see declaration of conformity)	To EU EMC Directive ²⁾
	To EC Machinery Directive
KC marking	KC-EMV

- 1) Corrosion resistance class CRC 1 to Festo standard FN 940070
Low corrosion stress. For dry indoor applications or transport and storage protection. Also applies to parts behind covers, in the non-visible interior area, and parts which are covered in the application (e.g. drive trunnions).
- 2) For information about the applicability of the component see the manufacturer's EC declaration of conformity at: www.festo.com/sp → Certificates.
If the component is subject to restrictions on usage in residential, office or commercial environments or small businesses, further measures to reduce the emitted interference may be necessary.

Materials

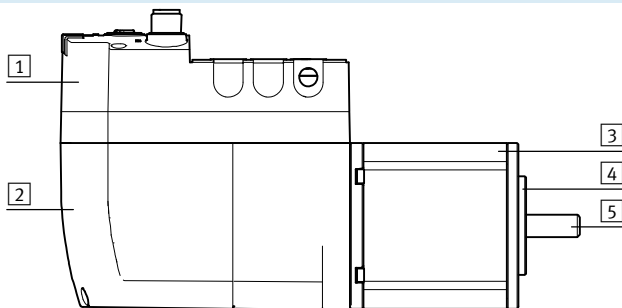

Integrated drive	
Housing	
1 Terminal box	Glass fibre-reinforced plastic
2 Lower housing part	Die-cast zinc
– Seals	NBR
Motor	
3 Housing profile	Aluminium
4 Flange	Die-cast zinc
5 Shaft	Steel
Note on materials	RoHS-compliant
	Contains paint-wetting impairment substances

Integrated drives EMCA

Technical data

Torque M as a function of rotational speed n

EMCA-EC-67-S

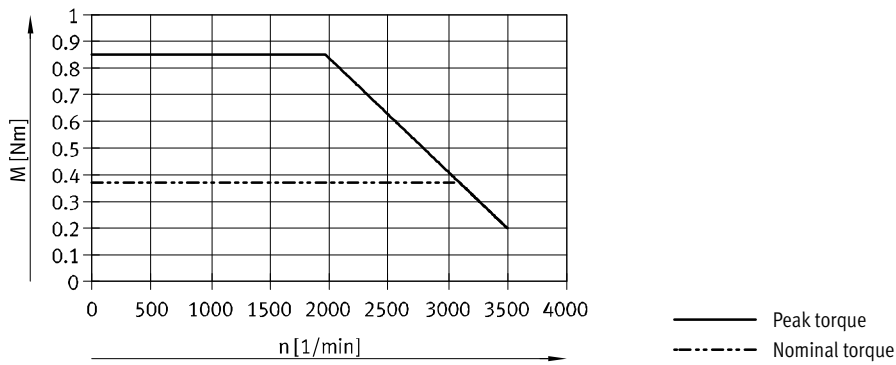

EMCA-EC-67-M

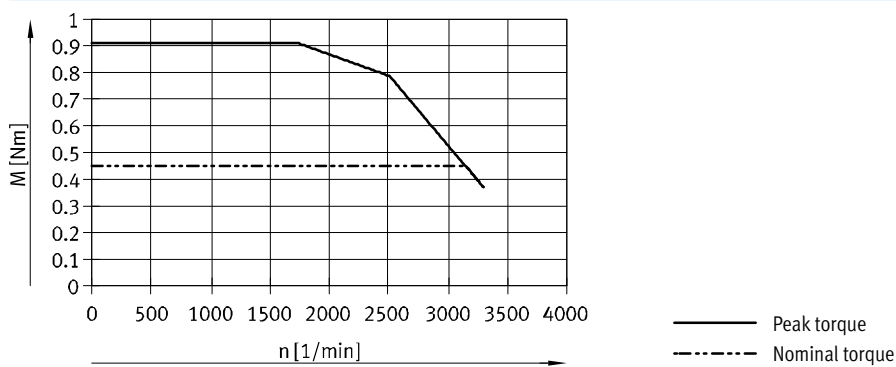

 Note
 Typical motor characteristics (typical production tolerances ±20%) at nominal voltage.

Integrated drives EMCA

Technical data

Pin allocation

EMCA...-DIO

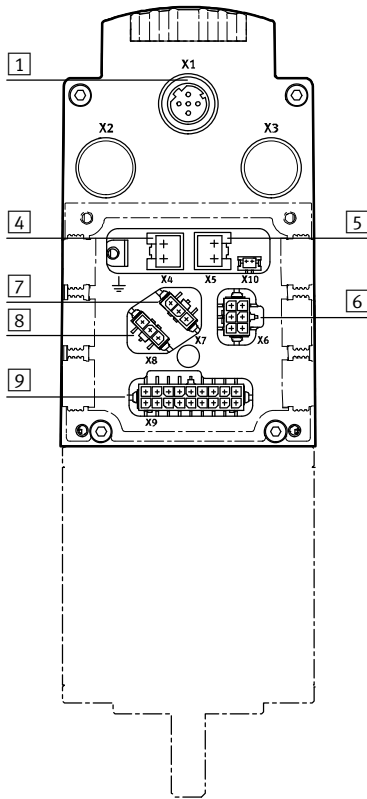

EMCA...-CO

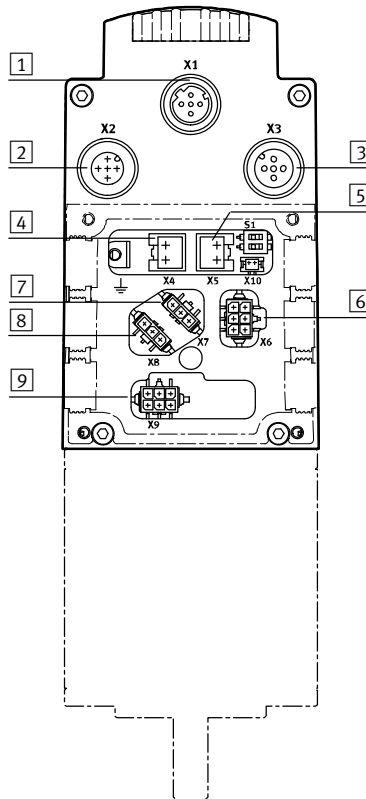

EMCA...-PN/-EP/-EC

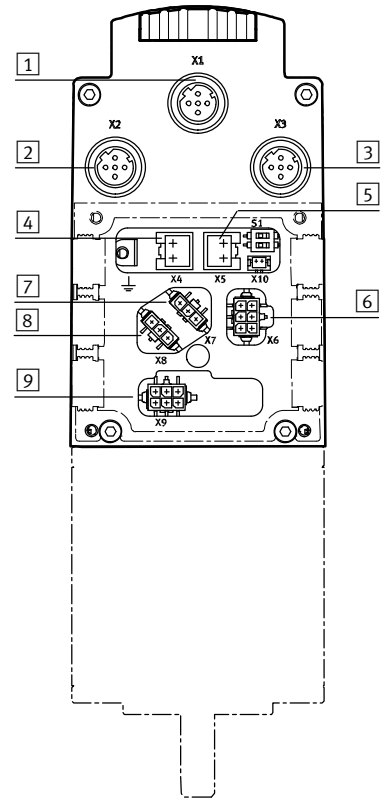

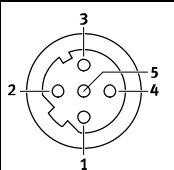
1 [X1] Parameterisation interface (Ethernet)		PIN	Function
	1	TD+	Transmitted data+
	2	RD+	Received data+
	3	TD-	Transmitted data-
	4	RD-	Received data-
	5	-	n.c.
	Housing		Shield/functional earth

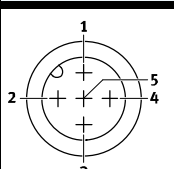
2 [X2] CAN IN (CAN interface)		PIN	Function
	1	CAN shield	Shielding
	2	n.c.	-
	3	CAN GND	CAN bus reference potential
	4	CAN H	CAN bus high
	5	CAN L	CAN bus low
	Housing		Shield/functional earth

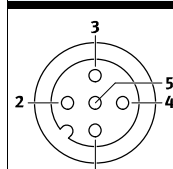
3 [X3] CAN OUT (CAN interface)		PIN	Function
	1	CAN shield	Shield
	2	n.c.	-
	3	CAN GND	CAN bus reference potential
	4	CAN H	CAN bus high
	5	CAN L	CAN bus low
	Housing		Shield/functional earth

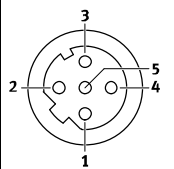
2 [X2] PN IN (PROFINET interface) [X2] EP IN (EtherNet/IP interface) [X2] EC IN (EtherCAT® interface)		PIN	Function
	1	TD+	Transmitted data+
	2	RD+	Received data+
	3	TD-	Transmitted data-
	4	RD-	Received data-
	5	-	n.c.
	Housing		Shield/functional earth

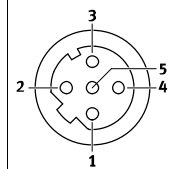
3 [X3] PN OUT (PROFINET interface) [X3] EP OUT (EtherNet/IP interface) [X3] EC OUT (EtherCAT® interface)		PIN	Function
	1	TD+	Transmitted data+
	2	RD+	Received data+
	3	TD-	Transmitted data-
	4	RD-	Received data-
	5	-	n.c.
	Housing		Shield/functional earth

Integrated drives EMCA

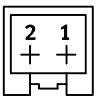

Technical data

Pin allocation

4 [X4] Power supply			
		PIN	Function
	1	24 V DC	Power supply
	2	GND	Reference potential

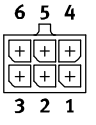
5 [X5] Braking resistor			
		PIN	Function
	1	ZK+	Connection for external braking resistor
	2	BR-CH	

6 [X6] STO interface			
		PIN	Function
	1	NC1	Acknowledgement contact 1
	2	NC2	Acknowledgement contact 2
	3	24 V DC	Voltage output
	4	STO1	Control input
	5	STO2	Control input
	6	GND	Reference potential

7/8 [X7/X8] Limit and reference switches			
		PIN	Function
	1	24 V DC	Voltage output
	2	Switch 1	Signal input 1
	3	GND	Reference potential
	1	24 V DC	Voltage output
	2	Switch 2	Signal input 2
	3	GND	Reference potential

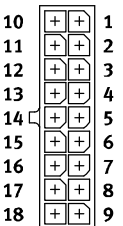
9 [X9] I/O interface on EMCA...-DIO			
		PIN	Function (mode0/mode1)
	1	DIN	Set selection 1
	2	DIN	Set selection 2
	3	DIN	Set selection 4
	4	DIN	Set selection 8
	5	DIN	Set selection 16
	6	DIN	Record selection 32/jog+
	7	DOUT	Ready
	8	DOUT	Configurable
	9	24 V DC	Voltage output
	10	DOUT	Start confirmed/teach confirmed
	11	DOUT	Motion complete
	12	DIN	Control mode 0/1
	13	DIN	Start/teach
	14	DIN	Open brake, delete remaining path/jog-
	15	DIN	Stop
	16	DIN	Release / acknowledge error
	17	-	n.c.
	18	GND	Reference potential

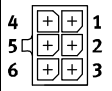
9 [X9] I/O interface on EMCA...-CO/-PN/-EP/-EC			
		PIN	Function
	1	DOUT	Ready
	2	DOUT	Configurable
	3	24 V DC	Voltage output
	4	DIN	Controller enable
	5	DIN	Sample input
	6	GND	Reference potential

10 [X10] External battery			
		PIN	Function
	1	Battery+	Connection for external battery
	2	Battery-	

Integrated drives EMCA

Technical data

Dimensions

Download CAD data → www.festo.com

EMCA-...-CO

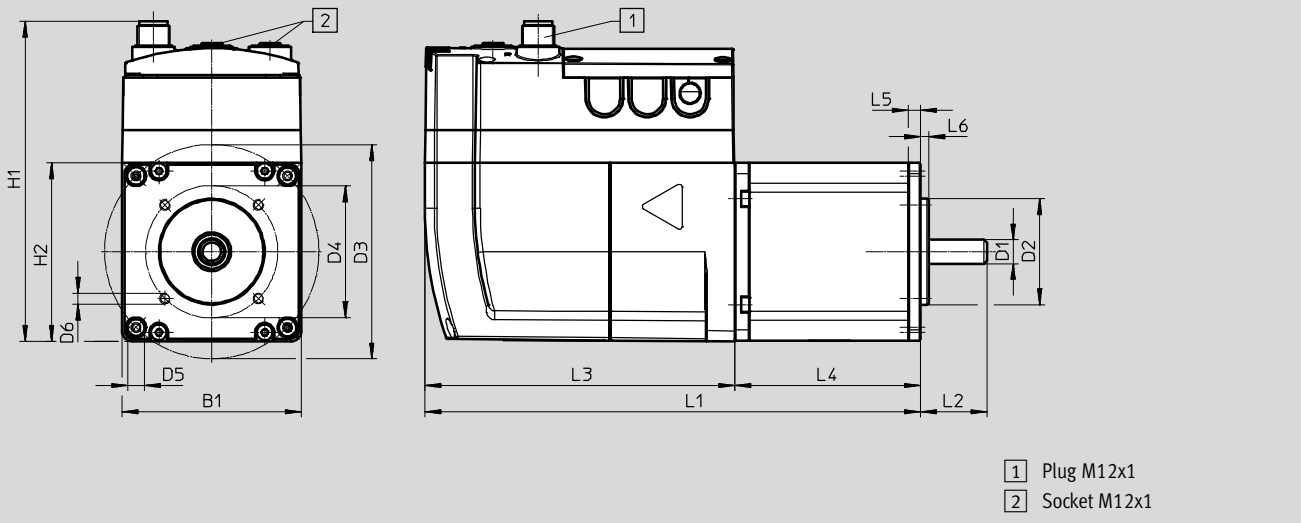

Type	B1	D1 ∅ h6	D2 ∅ h8	D3 ∅ ±0.2	D4 ∅ ±0.2	D5 ∅ +0.2	D6	H1 ±0.5
EMCA-...-S	67	9	40	81	50	6.3	M4x5	121.1
EMCA-...-M								

Type	H2	L1	L2 ±0.5	L3 ±0.3	L4 ±0.8	L5 ±0.3	L6 -0.1
EMCA-...-S	67	169.9	25	117.2	52.7	4.7	3
EMCA-...-M		187.4			70.2		

Integrated drives EMCA

Technical data

Dimensions

Download CAD data → www.festo.com

EMCA-...-PN/-EP/-EC/-DIO

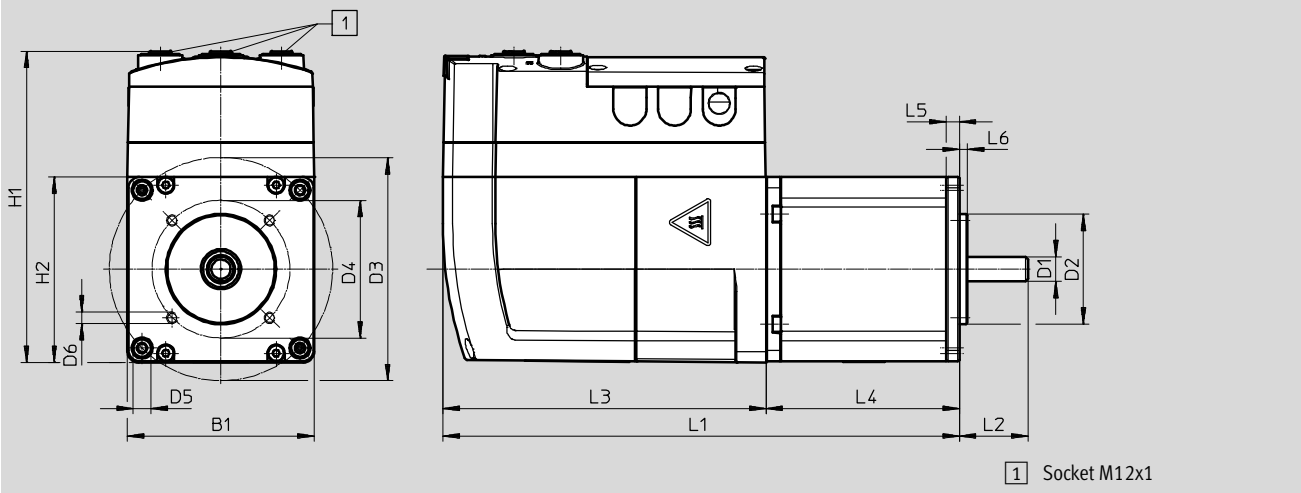

Type	B1	D1 ∅ h6	D2 ∅ h8	D3 ∅ ±0.2	D4 ∅ ±0.2	D5 ∅ +0.2	D6	H1 ±0.5
With PROFINET, EtherNet/IP, EtherCAT® interface								
EMCA-...-S	67	9	40	81	50	6.3	M4x5	113
EMCA-...-M								
With I/O interface								
EMCA-...-S	67	9	40	81	50	6.3	M4x5	111.5
EMCA-...-M								

Type	H2	L1	L2 ±0.5	L3 ±0.3	L4 ±0.8	L5 ±0.3	L6 -0.1
With PROFINET, EtherNet/IP, EtherCAT® interface							
EMCA-...-S	67	169.9	25	117.2	52.7	4.7	3
EMCA-...-M		187.4			70.2		
With I/O interface							
EMCA-...-S	67	169.9	25	117.2	52.7	4.7	3
EMCA-...-M		187.4			70.2		

Integrated drives EMCA

Technical data

Ordering data – Stock items						
Size		Measuring unit		Degree of protection	Part No.	Type
Short	Medium	Encoder, singleturn	Encoder, multiturn	IP54		
Interface: I/O with Modbus® TCP						
■		■		■	8061196	EMCA-EC-67-S-1TE-DIO
	■	■		■	8061197	EMCA-EC-67-M-1TE-DIO
■			■	■	8061199	EMCA-EC-67-S-1TM-DIO
	■		■	■	8061198	EMCA-EC-67-M-1TM-DIO
Interface: CANopen						
■		■		■	8034238	EMCA-EC-67-S-1TE-CO
	■	■		■	8034239	EMCA-EC-67-M-1TE-CO
■			■	■	8034240	EMCA-EC-67-S-1TM-CO
	■		■	■	8034241	EMCA-EC-67-M-1TM-CO
Interface: PROFINET						
■		■		■	8069725	EMCA-EC-67-S-1TE-PN
	■	■		■	8069726	EMCA-EC-67-M-1TE-PN
■			■	■	8069727	EMCA-EC-67-S-1TM-PN
	■		■	■	8069728	EMCA-EC-67-M-1TM-PN
Interface: EtherNet/IP						
■		■		■	8061201	EMCA-EC-67-S-1TE-EP
	■	■		■	8061202	EMCA-EC-67-M-1TE-EP
■			■	■	8061203	EMCA-EC-67-S-1TM-EP
	■		■	■	8061204	EMCA-EC-67-M-1TM-EP
Interface: EtherCAT®						
■		■		■	8069729	EMCA-EC-67-S-1TE-EC
	■	■		■	8069730	EMCA-EC-67-M-1TE-EC
■			■	■	8069731	EMCA-EC-67-S-1TM-EC
	■		■	■	8069732	EMCA-EC-67-M-1TM-EC

Integrated drives EMCA

Ordering data – Modular product system

Ordering table				
Size	67	Condi- tions	Code	Entry code
M Module no.	1509036			
Product type	EMCA motor with controller		EMCA	EMCA
Motor technology	EC motor		-EC	-EC
Flange size	67 mm		-67	-67
Overall length	Short		-S	
	Medium		-M	
Nominal operating voltage	24 V DC		-1	-1
Electrical connection	Terminal box		T	T
Measuring unit	Absolute encoder, singleturn		E	
	Absolute encoder, multiturn displacement encoder		M	
O Brake	None			
	With holding brake		B	
M Bus protocol/Control	Digital I/O interface with Modbus® TCP		-DIO	
	CANopen		-CO	
	PROFINET		-PN	
	EtherNet/IP		-EP	
	EtherCAT®		-EC	
O Degree of protection, electrical system	Standard			
	IP65		-S1	

M Mandatory data

O Options

Order code

Integrated drives EMCA

Accessories

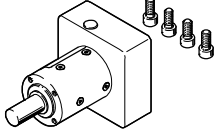
Ordering data					
	Gear unit type	Gear ratio		Part No.	Type
	EMGC-40-P...	3	Single-stage	8000594	EMGC-40-P-G3-SEC-67
				8000595	EMGC-40-P-G4-SEC-67
				8000596	EMGC-40-P-G5-SEC-67
				8000597	EMGC-40-P-G7-SEC-67
		12	Two-stage	8000598	EMGC-40-P-G12-SEC-67
				8000599	EMGC-40-P-G16-SEC-67
				8000600	EMGC-40-P-G20-SEC-67
				8000601	EMGC-40-P-G25-SEC-67
				8000602	EMGC-40-P-G35-SEC-67
				EMGC-60-P...	
8000613	EMGC-60-P-G4-SEC-67				
8000614	EMGC-60-P-G5-SEC-67				
8000615	EMGC-60-P-G7-SEC-67				
8000616	EMGC-60-P-G10-SEC-67				
12	Two-stage	8000617	EMGC-60-P-G12-SEC-67		
		8000618	EMGC-60-P-G16-SEC-67		
		8000619	EMGC-60-P-G20-SEC-67		
		8000620	EMGC-60-P-G25-SEC-67		
		8000621	EMGC-60-P-G35-SEC-67		
		40		8000622	EMGC-60-P-G40-SEC-67

Fitting instructions for EMGC-40

- Only suitable for vertical mounting position
- Suitable as a vertical axis where only the slide moves, for example, and not the axis
- Not suitable as a Z-axis as part of a three-dimensional gantry, for example

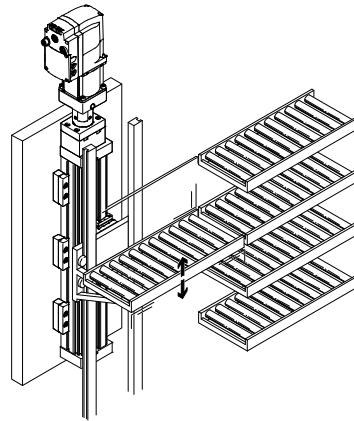

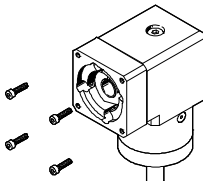
Ordering data				
	Gear unit type	Gear ratio	Part No.	Type
	EMGC-67-A-G1	1	2321480	EMGC-67-A-G1-SEC-67

 Products available ex-stock

Integrated drives EMCA

Accessories

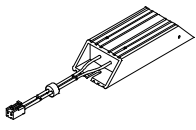
Ordering data – Braking resistor							
	Resistance value [Ω]	Nominal power [W]	Weight [g]	Degree of protection	Cable length [mm]	Dimensions [mm]	Part No. Type
	6	60	140	IP65	300	Length: 102 Width: 40 Height: 21	8047913 CACR-LE2-6-W60

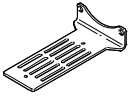
Ordering data – Mounting bracket			
	Description	Weight [g]	Part No. Type
	For flexible mounting of the braking resistor	106	8080406 EAHM-M1-AB

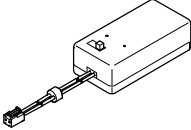
Ordering data – Battery box					
	Description	Degree of protection	Cable length [mm]	Dimensions [mm]	Part No. Type
	<ul style="list-style-type: none"> To save the position values in combination with the multiturn absolute displacement encoder It contains a standard 9 V battery (6LR61) 	IP40	135	Length: 68 Width: 33 Height: 25	8047912 EADA-A-9

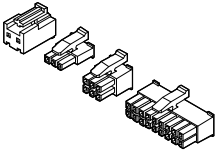
Ordering data – Assortment of plugs				
	Description	For bus protocol/control	Part No.	Type
	Connector plugs for power supply, reference/limit switch etc. (for plugs X4, X6, X7, X8, X9 → page 13) Not included in the scope of delivery of the EMCA	CANopen PROFINET EtherNet/IP EtherCAT®	8034242	NEKM-C-20
		I/O interface with Modbus® TCP	8034243	NEKM-C-21

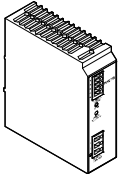
Ordering data – Power supply units					
	Description	Input voltage range [V AC]	Nominal output voltage [V DC]	Nominal output current [A]	Part No. Type
	Power supply for motor controller	100 ... 240	24	10	2247682 CACN-3A-1-10

Integrated drives EMCA

Accessories

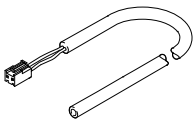
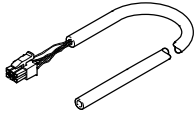
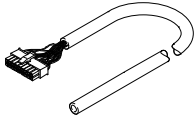
Ordering data – Pre-assembled cable				
	Description	Cable length [m]	Part No.	Type
For power supply (plug X4) for EMCA-...-CO/-PN/-EP/-EC/-DIO				
	Electrical connection: One end: pre-assembled with plug, other end: open cable end	10	4977492	NEBM-L4G2-E-10-N-LE2
For STO interface (plug X6) for EMCA-...-CO/-PN/-EP/-EC/-DIO and I/O interface (plug X9) for EMCA-...-CO/-PN/-EP/-EC				
	Electrical connection: One end: pre-assembled with plug, other end: open cable end	10	4977493	NEBM-L5G6-E-10-N-LE6
For I/O interface (plug X9) for EMCA-...-DIO				
	Electrical connection: One end: pre-assembled with plug, other end: open cable end	10	4977494	NEBM-L5G18-E-10-N-LE18

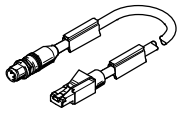
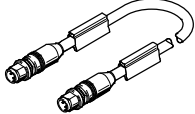
Ordering data – Connecting cable				
	Cable length [m]	Weight [g]	Part No.	Type
For parameterisation interface (plug X1)				
	1	89	8040451	NEBC-D12G4-ES-1-S-R3G4-ET
	3	219	8040452	NEBC-D12G4-ES-3-S-R3G4-ET
	5	347	8040453	NEBC-D12G4-ES-5-S-R3G4-ET
	10	674	8040454	NEBC-D12G4-ES-10-S-R3G4-ET
For PROFINET, EtherNet/IP, EtherCAT interface (plug X2, X3)				
	0.5	57	8040446	NEBC-D12G4-ES-0.5-S-D12G4-ET
	1	93	8040447	NEBC-D12G4-ES-1-S-D12G4-ET
	3	223	8040448	NEBC-D12G4-ES-3-S-D12G4-ET
	5	350	8040449	NEBC-D12G4-ES-5-S-D12G4-ET
	10	679	8040450	NEBC-D12G4-ES-10-S-D12G4-ET

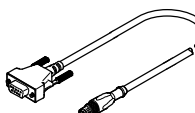
Ordering data – Fieldbus adapters for CANopen			
	Description	Part No.	Type
	<ul style="list-style-type: none"> For connecting standard M12 CANopen cables 9-pin Sub-D plug to 5-pin round M12 plug Bus terminating resistor must be connected externally 	540324	FBA-CO-SUB-9-M12

 **Note**
Spare parts:
→ www.festo.com/emca
(documentation)