

Angle grippers DHWS

FESTO



Angle grippers DHWS

Key features

FESTO

At a glance

General information

- Improved gripper jaw guide
- Slotted guide system
- Max. repetition accuracy
- Gripping force retention
- Internal fixed flow control
- Wide range of options for mounting on drive units

- Sensor technology:
 - Adaptable position sensor for the small gripper sizes
 - Integratable proximity sensors for the medium and large gripper sizes

Flexible range of applications

- Can be used as a double-acting and single-acting gripper
- Compression spring for supplementary or retaining gripping forces
- Suitable for external and internal gripping

The technology in detail

Gripper closed

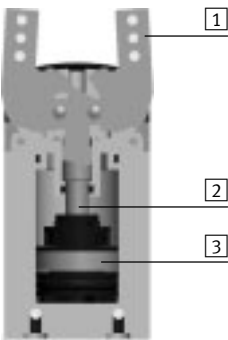

Gripper open



- 1 Gripper jaw
- 2 Slotted guide plate
- 3 Piston with magnet

-  - Note

Gripper selection sizing software
[→ www.festo.com](http://www.festo.com)

Position sensing/force control

With position transmitter SMAT-8M, SDAT



- Analogue positional feedback possible
- Analogue output
 - 0 ... 10 V
 - 4 ... 20 mA

With proportional pressure regulator VPPM



- Infinite adjustment of the gripping force possible
- Setpoint input
 - 0 ... 10 V
 - 4 ... 20 mA

With proximity sensor SMT-8G



- Multiple positions can be sensed:
- Open
 - Closed
 - Workpiece gripped

Angle grippers DHWS

Key features

Supply ports

At the side

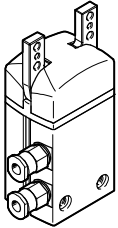

Mounting options

At the side

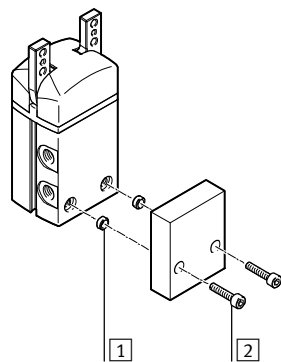
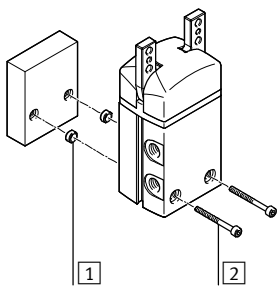

From underneath

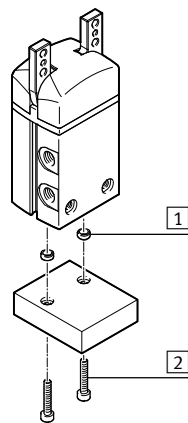

- 1 Centring sleeves
- 2 Mounting screws

Mounting options for external gripper fingers

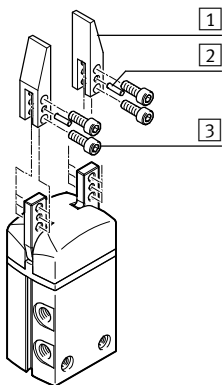

- 1 Gripper fingers
- 2 Centring pins
- 3 Mounting screws

Note

These grippers are not designed for the following or similar sample applications:

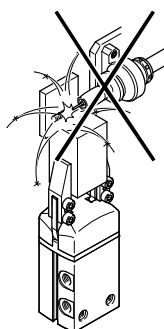

- Welding spatter

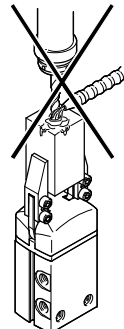

- Machining
- Aggressive media

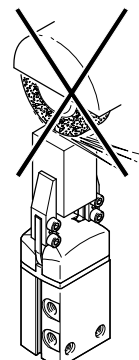

- Grinding dust

Angle grippers DHWS

Peripherals overview

Peripherals overview

DHWS-10

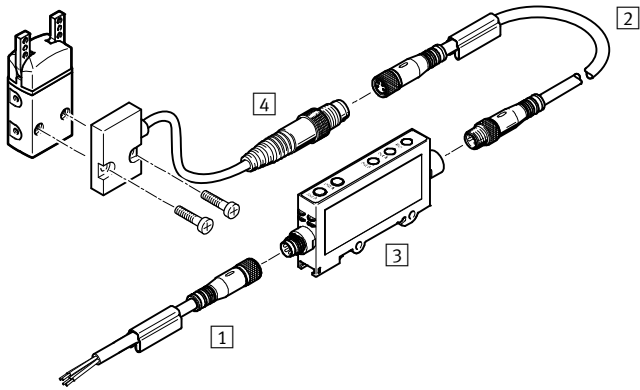

DHWS-16 ... 40

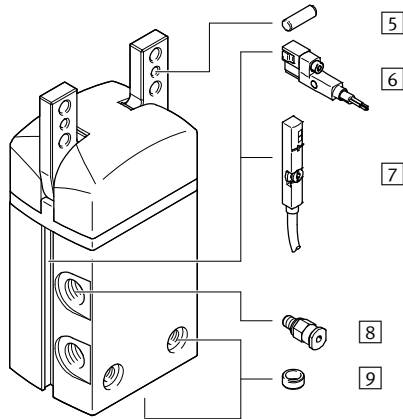

System product for handling and assembly technology

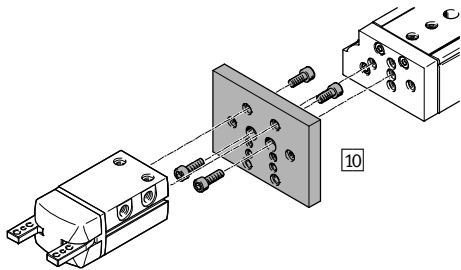

Proportional pressure regulator VPPM

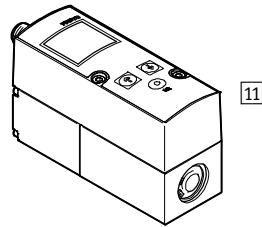

Angle grippers DHWS

Peripherals overview

Accessories				
	Type	Size	Description	→ Page/Internet
1	Connecting cable NEBU	10	<ul style="list-style-type: none"> • Connection between signal converter and controller 	20
2	Connecting cable NEBU	10	<ul style="list-style-type: none"> • Connection between position sensor and signal converter 	20
3	Signal converter SVE4	10	<ul style="list-style-type: none"> • For evaluating signals for position sensor SMH-S1 	20
4	Position sensor SMH-S1	10	<ul style="list-style-type: none"> • Adaptable and integratable sensor technology, for sensing the piston position 	20
5	Centring pin	10 ... 40	<ul style="list-style-type: none"> • For centring the gripper fingers on the gripper jaws 	–
6	Proximity sensor SMT-8G	16 ... 40	<ul style="list-style-type: none"> • For sensing the piston position • Proximity sensor does not project past the housing at the bottom 	21
7	Position transmitter SMAT-8M	16 ... 40	<ul style="list-style-type: none"> • Continuously senses the position of the piston. Has an analogue output with an output signal in proportion to the piston position 	21
	Position transmitter SDAT	32, 40		
8	Push-in fitting QS	10 ... 40	<ul style="list-style-type: none"> • For connecting compressed air tubing with standard O.D. 	qs
9	Centring sleeve ZBH	10 ... 40	<ul style="list-style-type: none"> • For centring the gripper during mounting • The scope of delivery of the gripper includes 2 centring sleeves 	20
10	Adapter kit HMSV, HAPG, HAPS, HMVA	10 ... 40	<ul style="list-style-type: none"> • Connecting plate between drive and gripper 	16
11	Proportional pressure regulator VPPM	10 ... 40	<ul style="list-style-type: none"> • For infinite adjustment of the gripping force 	vppm

Angle grippers DHWS

Type codes

DHWS		-	16	-	A	-	
Type							
DHWS	Angle gripper						
Size							
Position sensing							
A	Via proximity sensor						
Gripping force retention							
NC	Closing						

Angle grippers DHWS

Technical data

FESTO

Function

Double-acting
DHWS-...-A

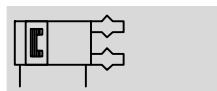

Size
10 ... 40 mm

Opening angle
40°

www.festo.com

Function – Variants

Single-acting or
with gripping force retention ...
... closing DHWS-...-NC



General technical data					
Size	10	16	25	32	40
Design	Lever				
Mode of operation	Double-acting				
Gripper function	Angle				
Guide	Plain-bearing guide				
Gripping force retention	–	NC	NC	NC	NC
Number of gripper jaws	2				
Opening angle per gripper jaw	[°] 20				
Pneumatic connection	M3	M3	M5	G1/8	G1/8
Repetition accuracy ¹⁾	[mm] ≤ 0.04				
Max. interchangeability	[mm] ≤ 0.2				
Max. operating frequency	4		3		
Rotational symmetry	[mm] < Ø 0.2				
Position sensing	Via position sensor		Via proximity sensor, position transmitter		
Type of mounting	Via through-hole and centring sleeve				
	Via female thread and centring sleeve				
Mounting position	Any				

1) End-position drift under constant conditions of use with 100 consecutive strokes in the direction of movement of the gripper jaws

Operating and environmental conditions					
Size	10	16	25	32	40
Min. operating pressure					
DHWS-...-A	[bar] 2				
DHWS-...-A-NC	[bar] –	4			
Max. operating pressure	[bar] 8				
Operating medium	Compressed air in accordance with ISO 8573-1:2010 [7:4:4]				
Note on operating/pilot medium	Operation with lubricated medium possible (in which case lubricated operation will always be required)				
Ambient temperature ¹⁾	[°C] +5 ... +60				
Corrosion resistance class CRC ²⁾	1				

1) Note operating range of proximity sensors

2) Corrosion resistance class CRC 1 to Festo standard FN 940070

Low corrosion stress. For dry indoor applications or transport and storage protection. Also applies to parts behind covers, in the non-visible interior area, and parts which are covered in the application (e.g. drive trunnions).

Weight [g]					
Size	10	16	25	32	40
DHWS-...-A	40	110	258	452	775
DHWS-...-A-NC	–	114	265	462	790

Angle grippers DHWS

Technical data

FESTO

Materials

Sectional view

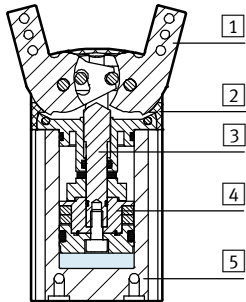

Angle gripper		
1	Gripper jaw	High-alloy stainless steel
2	Cover cap	Polyamide
3	Slotted guide plate	Tempered steel
4	Piston	Polyacetal
5	Housing	Hard anodised wrought aluminium alloy
-	Seals	Nitrile rubber
-	Note on materials	Free of copper and PTFE RoHS-compliant

Total gripping torque [Ncm] at 6 bar

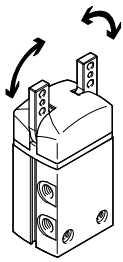

Size		10	16	25	32	40
DHWS-...-A	Opening	43	129	386	810	1497
	Closing	30	114	356	746	1362

Static characteristic load values at the gripper jaws

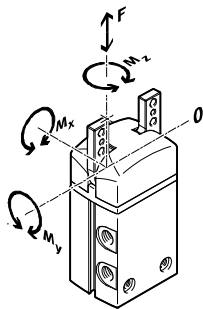

The indicated permissible forces and torques apply to a single gripper jaw. They include the lever arm, additional applied loads due to the workpiece or external gripper fingers and accelera-

tion forces occurring during movement.

The zero coordinate line (gripper jaw guide) must be taken into consideration for the calculation of torques.

Size		10	16	25	32	40
Max. permissible force F_z	[N]	25	50	90	120	200
Max. permissible torque M_x	[Nm]	0.6	1.6	3.6	6	13
Max. permissible torque M_y	[Nm]	0.6	1.6	3.6	6	13
Max. permissible torque M_z	[Nm]	0.6	1.6	3.6	6	13

Mass moment of inertia [$\text{kgm}^2 \times 10^{-4}$]

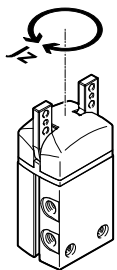

Mass moment of inertia of the angle gripper in relation to the central axis, without external gripper fingers, without load.

Size		10	16	25	32	40
DHWS-...-A		0.03	0.14	0.62	1.60	3.81
DHWS-...-A-NC		-	0.15	0.64	1.63	3.87

Angle grippers DHWS

Technical data

Opening and closing times [ms] at 6 bar

Without external gripper fingers

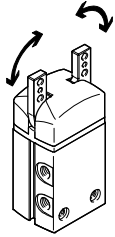

The indicated opening and closing times [ms] were measured at room temperature at an operating pressure of 6 bar with horizontally mounted grippers without additional gripper

fingers (average values). The grippers must be throttled for greater applied loads. Opening and closing times must then be adjusted accordingly.

Size		10	16	25	32	40
Without external gripper fingers						
DHWS-...-A	Opening	10	44	64	46	63
	Closing	22	52	80	77	96
DHWS-...-A-NC	Opening	-	62	106	88	99
	Closing	-	36	59	55	69

Opening and closing times t to be set at 6 bar as a function of mass moment of inertia of the gripper fingers

DHWS-10

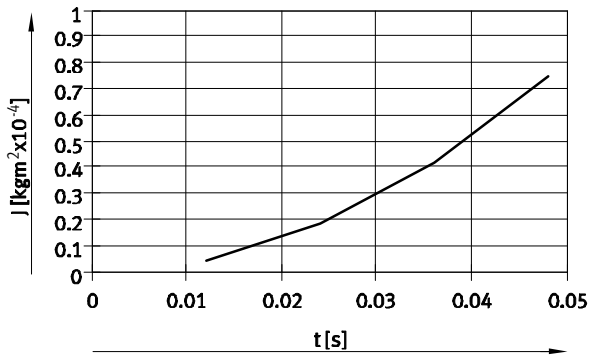

DHWS-16

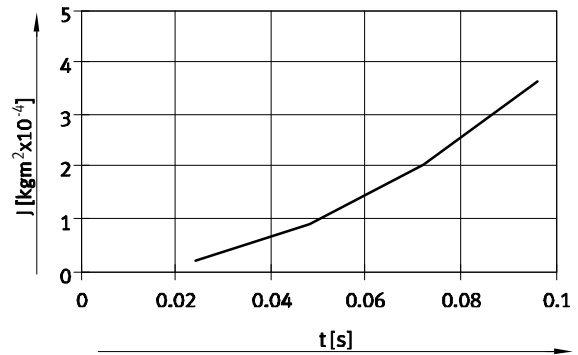

DHWS-25

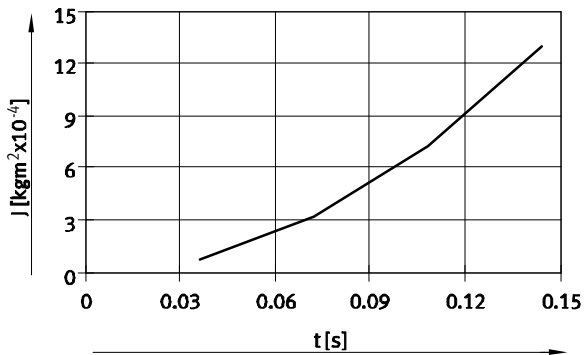

DHWS-32

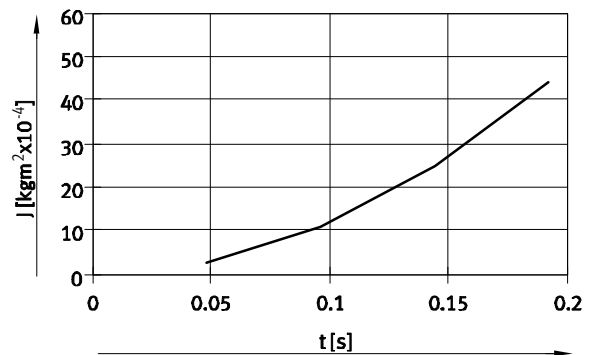

DHWS-40

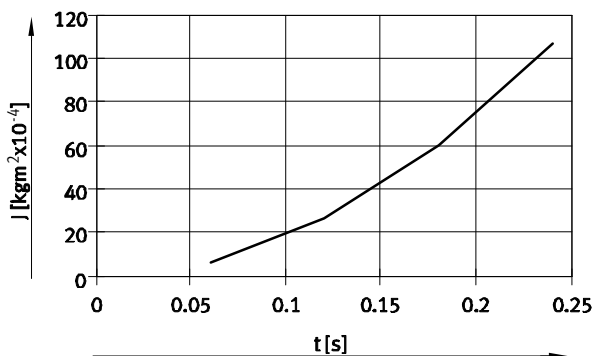

Angle grippers DHWS

Technical data

Gripping force F_H per gripper jaw as a function of operating pressure and lever arm x

The gripping forces as a function of operating pressure and lever arm can be determined from the following graphs.

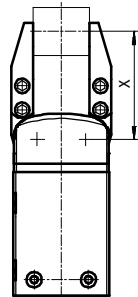

Note
Gripper selection
sizing software
→ www.festo.com

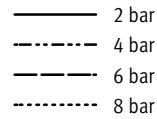

External gripping (closing)

DHWS-10

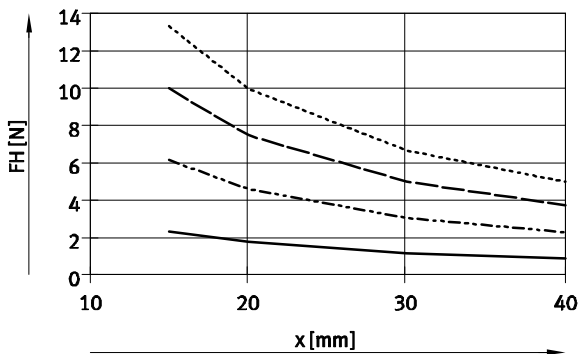

DHWS-16

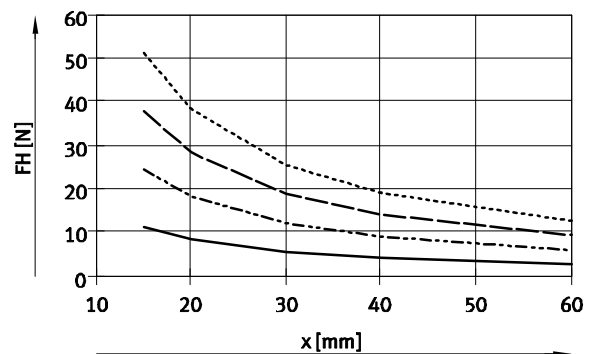

DHWS-25

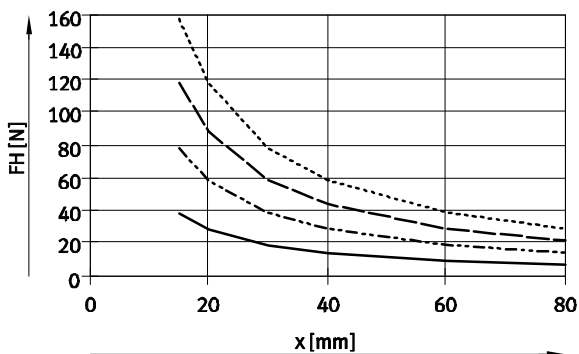

DHWS-32

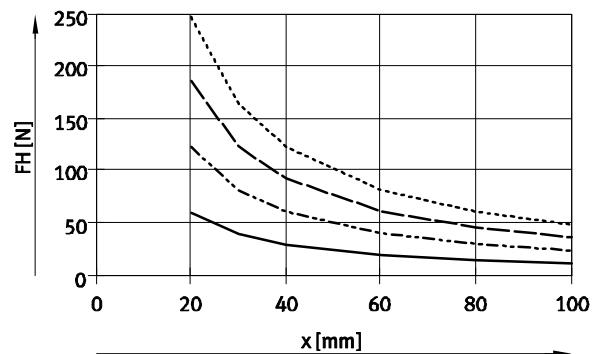

DHWS-40

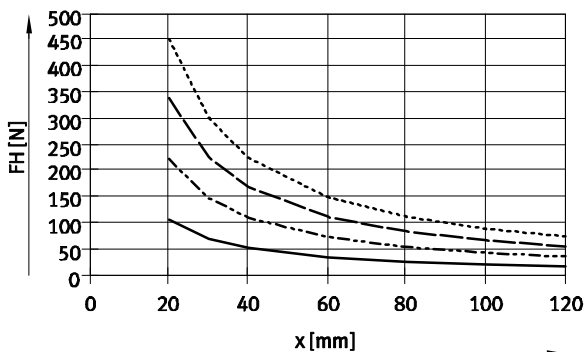

Angle grippers DHWS

Technical data

Gripping force F_H per gripper jaw as a function of operating pressure and lever arm x

The gripping forces as a function of operating pressure and lever arm can be determined from the following graphs.

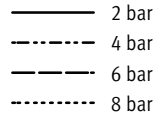
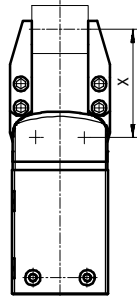

Note
 Gripper selection
 sizing software
 → www.festo.com

Internal gripping (opening)

DHWS-10

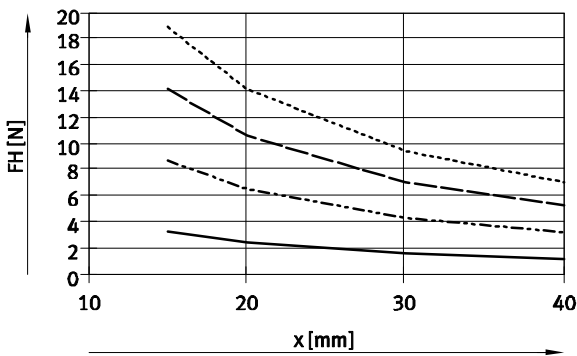

DHWS-16

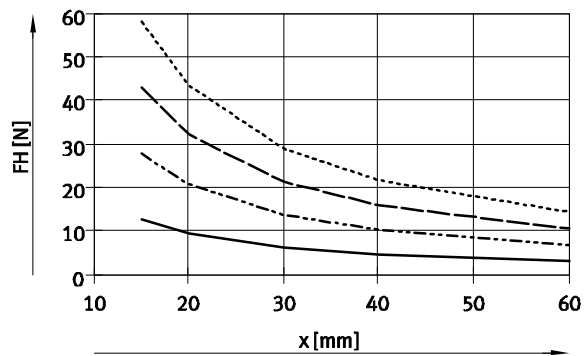

DHWS-25

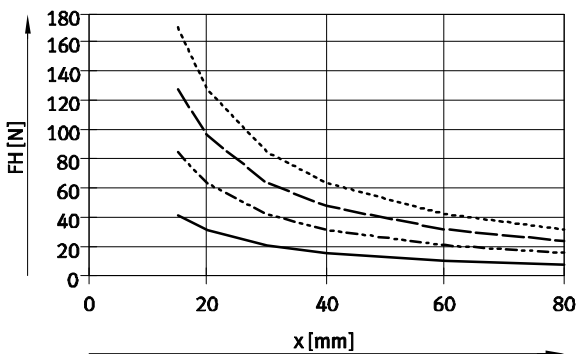

DHWS-32

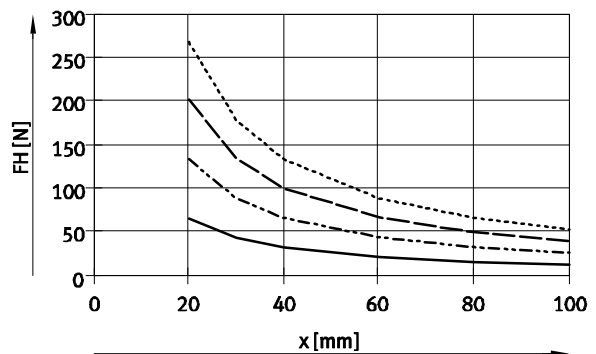

DHWS-40

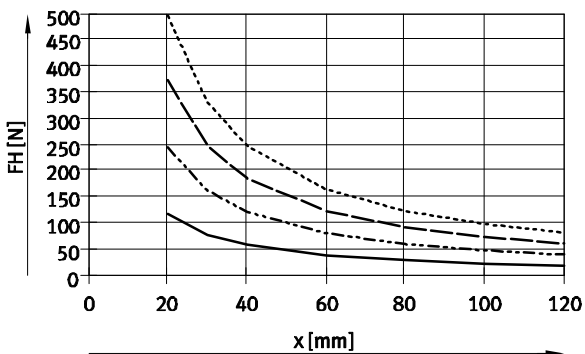

Angle grippers DHWS

Technical data

Gripping force F_H per gripper jaw at 6 bar as a function of lever arm x and eccentricity a and b

The following formula must be used to calculate the lever arm x with eccentric gripping:

$$x = \sqrt{a^2 + b^2}$$

The gripping force F_H can be read from the graphs (→ page 10/11) using the calculated value x .

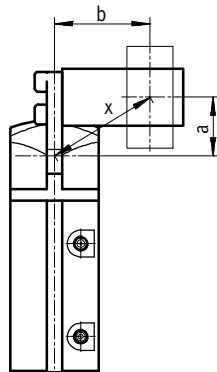

Calculation example

Given:

Distance $a = 20$ mm

Distance $b = 25$ mm

To be calculated:

The gripping force at 6 bar, with a DHWS-16, used as an external gripper

Procedure:

Calculating the lever arm x

$$x = \sqrt{20^2 + 25^2}$$

$$x = 32$$
 mm

The graph (→ page 10) gives a value of $F_H = 18$ N for the gripping force.

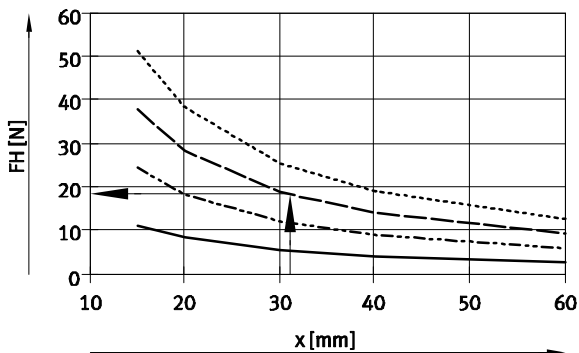

Angle grippers DHWS

Technical data

Spring torque M_F as a function of opening angle α

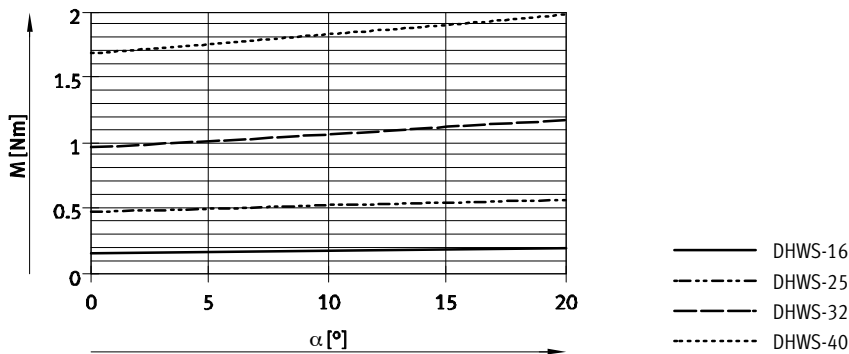

Determination of the actual gripping torques $M_{Grtotal}$ for DHWS-...-NC as a function of application

The angle gripper with integrated spring type DHWS-...-NC (closing gripping force retention) can be used as:

- single-acting grippers
- grippers with supplementary gripping force and
- grippers with gripping force retention depending on requirements.

In order to calculate the available gripping torque $M_{Grtotal}$ (per gripper jaw), the data from the graphs for the

gripping force F_H (→ page 10/11) and the spring torque M_F (→ page 13) must be combined accordingly.

$$M_{Gr} = F_H * x$$

M_{Gr} Gripping torque
 F_H Gripping force
 x Lever arm

Application

Single-acting

- Gripping with spring force:
 $M_{Grtotal} = M_F$
- Gripping with pressure force:
 $M_{Grtotal} = M_{Gr} - M_F$

Supplementary gripping force

- Gripping with pressure and spring force:
 $M_{Grtotal} = M_{Gr} + M_F$

Gripping force retention

- Gripping with spring force:
 $M_{Grtotal} = M_F$

Angle grippers DHWS

Technical data

FESTO

Dimensions

Download CAD data → www.festo.com

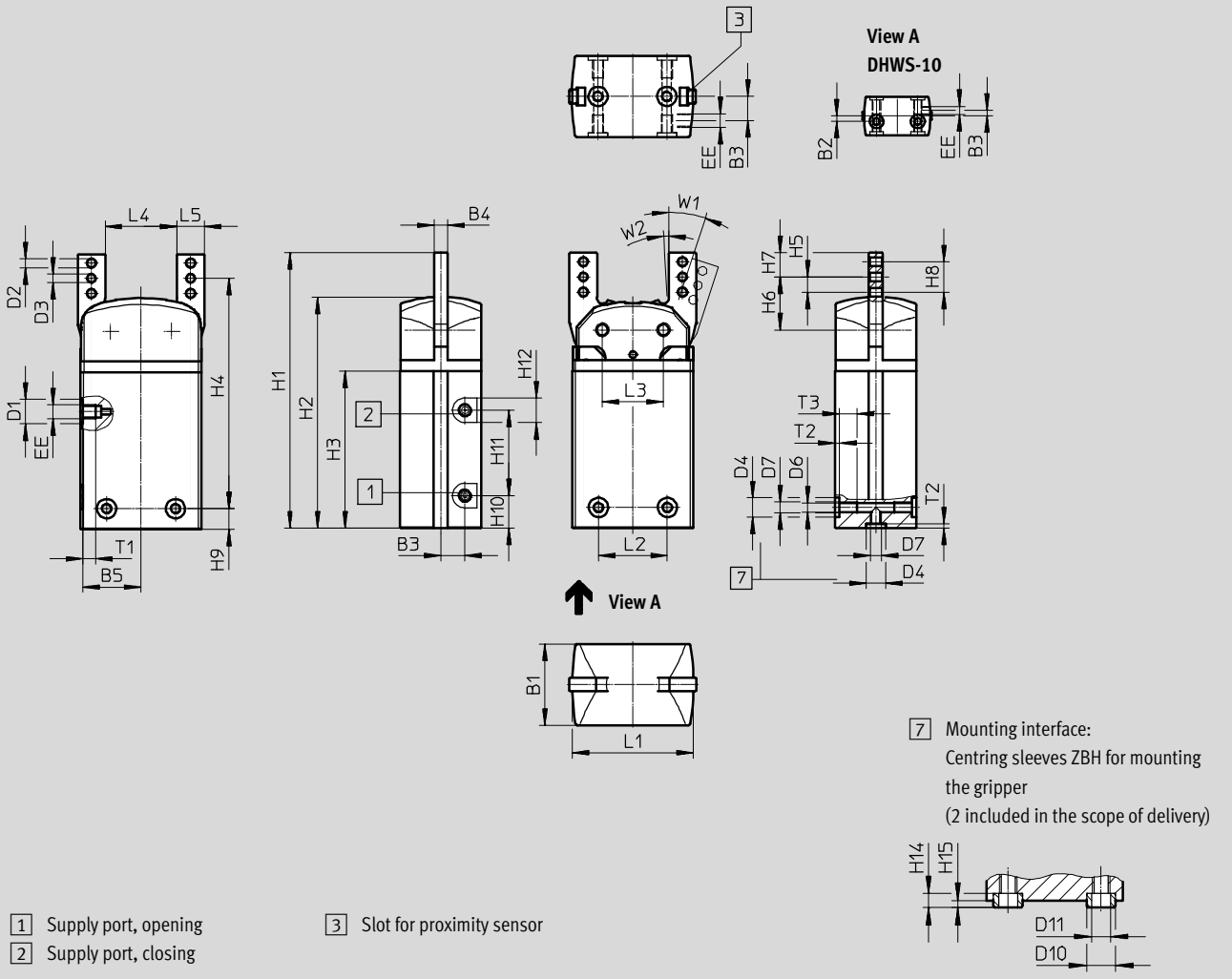

Size	B1	B2 ¹⁾	B3	B4	B5	D1	D2	D3	D4	D6	D7
[mm]	±0.05			-0.03/ -0.05		∅	∅ ±0.1	∅ H8	∅ H8/h7	+0.1	
10	14	2	2	3	11.6	7	2.2	2	5	2.4	M3
16	19	-	5.8	4	16	-	3.2	2.5	5	2.5	M3
25	29.5	-	8.75	5	21	9	3.2	3	7	3.3	M4
32	38	-	11	6	24	15	4.3	3	9	5.1	M6
40	49	-	11	8	28.4	15	5.3	4	12	6.4	M8

Size	D10	D11	EE	H1	H2	H3	H4	H5	H6	H7
[mm]	∅ h7	∅					±0.2		±0.05	
10	5	3.2	M3	56.3	46	30.8	38.25	3.5	10.95	5.75
16	5	3.2	M3	81	67	45.5	66	4.5	15.5	7.5
25	7	5.3	M5	100	84	57	83.7	5.5	19.2	8.8
32	9	6.4	G1/8	116	96.2	65	100.5	6.5	22.5	11
40	12	10.3	G1/8	129	108.4	71.5	99.5	7	24.5	12

1) Tolerance for centring hole ±0.02 mm; tolerance for thread ±0.1 mm

Angle grippers DHWS

Technical data

FESTO

Size [mm]	H8	H9 ²⁾	H10	H11	H12	H14	H15	L1	L2 ¹⁾
						-0.2	-0.3	±0.05	
10	7	12.3	8.8	16	7	2.4	1.2	24	15
16	9	7.5	12.25	23	7	2.4	1.2	34	16
25	11	7.5	11.8	31	9	3	1.4	44	25
32	13	11	20	25	15	4	1.9	53	29
40	14	17.5	9	46	15	5	2.4	59	33

Size [mm]	L3	L4	L5 -0.02/ -0.05	T1	T2	T3	W1	W2
	±0.02			+0.5	+0.1	+1	+3°/-1°	±1°
10	12.4	14	5.5	3.5	1.2	through	18	3
16	17	18	8	4.5	1.2	5.8	18	3
25	22.2	26	10	4.5	1.6	6.4	18	3
32	25.8	29	12	7.5	2.1	12.9	18	3
40	30	32	15	6	2.6	13.4	18	3

1) Tolerance for centring hole ±0.02 mm; tolerance for thread ±0.1 mm

2) Tolerance for centring hole -0.05 mm; tolerance for thread ±0.1 mm

Ordering data				
Size [mm]	Double-acting without compression spring		Single-acting or with gripping force retention	
	Part No.	Type	Closing Part No.	Type
10	1310177	DHWS-10-A	-	
16	1310178	DHWS-16-A	1310179	DHWS-16-A-NC
25	1310180	DHWS-25-A	1310181	DHWS-25-A-NC
32	1310182	DHWS-32-A	1310183	DHWS-32-A-NC
40	1310184	DHWS-40-A	1310185	DHWS-40-A-NC

Angle grippers DHWS



Accessories

FESTO

Adapter kit
HAPG, HAPS, HMSV

Material:
Wrought aluminium alloy
Free of copper and PTFE
RoHS-compliant

 Note
The kit includes the individual mounting interface as well as the necessary mounting material.

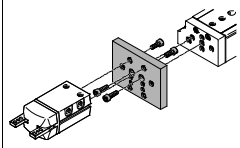
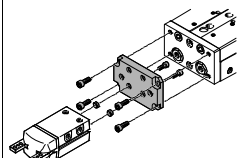
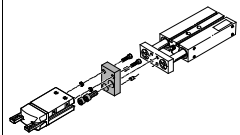
Permissible drive/gripper combinations with adapter kit						Download CAD data → www.festo.com	
Combination	Drive Size	Gripper		Adapter kit			
		Size	Mounting option		CRC ¹⁾	Part No.	Type
							
DGSL/DHWS	DGSL	DHWS		HMSV			
	8, 10	10	■	■	2	548784	HMSV-54
	12, 16	16	■	■		548785	HMSV-55
	20, 25	25, 32	■	■		548786	HMSV-56
SLT/DHWS	SLT	DHWS		HAPS			
	10	10	■	–	2	178448	HAPS-2
	16	16	■	–		178449	HAPS-3
	20	25	■	–		178450	HAPS-4
	25	32	■	–		178451	HAPS-5
DPZ/DHWS	DPZ	DHWS		HAPG			
	10, 16	16	■	–	2	163250	HAPG-1
	16	25	■	–		163251	HAPG-2
	20	25	■	–		163252	HAPG-3
	25, 32	32	■	–		163253	HAPG-4

1) Corrosion resistance class CRC 2 to Festo standard FN 940070
Moderate corrosion stress. Indoor applications in which condensation may occur. External visible parts with primarily decorative requirements for the surface and which are in direct contact with the ambient atmosphere typical for industrial applications.

Angle grippers DHWS



Accessories



Adapter kit
DHAA, HAPG, HMSV, HMVA,

Material:
Wrought aluminium alloy
Free of copper and PTFE
RoHS-compliant

 Note
The kit includes the individual mounting interface as well as the necessary mounting material.

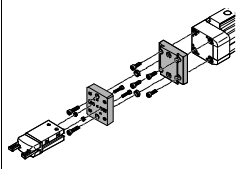
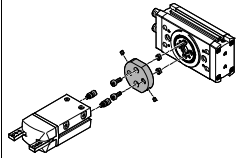
Permissible drive/gripper combinations with adapter kit					Download CAD data → www.festo.com		
Combination	Drive Size	Gripper Size	Mounting option		Adapter kit		
					CRC ¹⁾	Part No.	Type
DGP..., DGE..., DGEA/DHWS	DG...	DHWS				HMVA, HAPG, HMSV	
	Direct mounting						
	18 ²⁾ , 25 ³⁾	10	■	■	2	196788	HMVA-DLA18/25
						192706	HAPG-37-S1
	40 ³⁾	10	■	■		196790	HMVA-DLA40
						192706	HAPG-37-S1
	18 ²⁾ , 25 ³⁾	16	■	■		196788	HMVA-DLA18/25
						192705	HAPG-36-S1
	40 ³⁾	16	■	■		196790	HMVA-DLA40
						192705	HAPG-36-S1
	18 ²⁾ , 25 ³⁾	25	■	■		196788	HMVA-DLA18/25
						193922	HAPG-37-S4
	40 ³⁾	25	■	■		196790	HMVA-DLA40
						193922	HAPG-37-S4
	Dovetail mounting						
18 ²⁾ , 25	16	■	■	2		196788	HMVA-DLA18/25
					177767	HMSV-27	
40	16	■	■		196790	HMVA-DLA40	
					177767	HMSV-27	
18 ²⁾ , 25	25	■	■		196788	HMVA-DLA18/25	
					177768	HMSV-28	
40	25	■	■		196790	HMVA-DLA40	
					177768	HMSV-28	
40	32	■	■		196790	HMVA-DLA40	
					177769	HMSV-29	
40	40	■	■		196790	HMVA-DLA40	
					177770	HMSV-30	
DRRD/DHWS	DRRD	DHWS				DHAA	
	8	10	■	■	2	2816591	DHAA-G-Q11-8-B2/B3-10
	10	10	■	■		2816068	DHAA-G-Q11-10-B2/B3-10
	12	10	■	■		2814790	DHAA-G-Q11-12-B2/B3-10
	12	16	■	■		2811183	DHAA-G-Q11-12-B2/B3-16
	16	16	■	■		1979085	DHAA-G-Q11-16-B2/B3-16
	16	25	■	■		1978889	DHAA-G-Q11-16-B2/B3-25
	20	25	■	■		1978443	DHAA-G-Q11-20-B2/B3-25
	20	32	■	■		1979912	DHAA-G-Q11-20-B2/B3-32
	25	25	■	■		1801802	DHAA-G-Q11-25-B2/B3-25
	25	32	■	■		1802969	DHAA-G-Q11-25-B2/B3-32
	32	32	■	■		1979992	DHAA-G-Q11-32-B2/B3-32
	32	40	■	■		1980014	DHAA-G-Q11-32-B2/B3-40
	35, 40	40	■	■		1980059	DHAA-G-Q11-35/40-B2/B3-40

1) Corrosion resistance class CRC 2 to Festo standard FN 940070
Moderate corrosion stress. Indoor applications in which condensation may occur. External visible parts with primarily decorative requirements for the surface and which are in direct contact with the ambient atmosphere typical for industrial applications.

2) Only for DGEA-...

3) Only for DGE.../DGP...

Angle grippers DHWS



Accessories

FESTO

Adapter kit
DHAA, HAPG

Material:
Wrought aluminium alloy
Free of copper and PTFE
RoHS-compliant

 Note
The kit includes the individual mounting interface as well as the necessary mounting material.

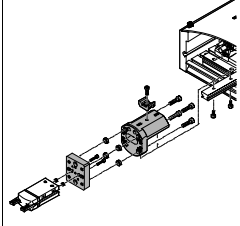
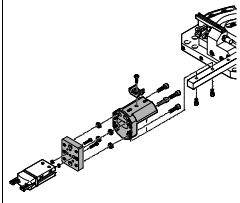
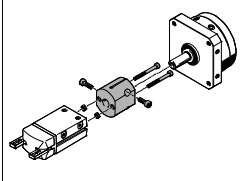
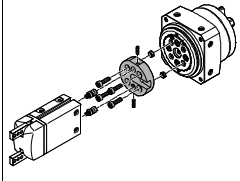
Permissible drive/gripper combinations with adapter kit							Download CAD data → www.festo.com	
Combination	Drive Size	Gripper Size	Mounting option		Adapter kit			
					CRC ¹⁾	Part No.	Type	
HSP/DHWS	HSP	DHWS			HAPG			
	12	10	■	–	2	192709	HAPG-60-S1	
						540881	HAPG-70-B	
	16	10	■	–		192706	HAPG-37-S1	
						540882	HAPG-71-B	
	16	16	■	–		192705	HAPG-36-S1	
				540882	HAPG-71-B			
	25	16	■	–	192705	HAPG-36-S1		
					540883	HAPG-72-B		
	25	25	■	–	193922	HAPG-37-S4		
					540883	HAPG-72-B		
HSW/DHWS	HSW	DHWS			HAPG			
	12, 16	10	■	–	2	192706	HAPG-37-S1	
						540882	HAPG-71-B	
	12, 16	16	■	–		192705	HAPG-36-S1	
					540882	HAPG-71-B		
DSM/DHWS	DSM-...-FW	DHWS			HAPG			
	6, 8, 10	10	■	■	2	187568	HAPG-34	
	DSM-...	DHWS			HAPG			
	12	16	■	■	2	163266	HAPG-17	
	16	16	■	■		163267	HAPG-18	
	16	25	■	■		163268	HAPG-19	
	25	25	■	■		163269	HAPG-20	
	25	32	■	■		163270	HAPG-21	
	32	32	■	■		163271	HAPG-22	
DSM-...-HD/DHWS	DSM-...-HD	DHWS				DHAA		
	12	16	■	■	2	8072157	DHAA-G-R3-12-B18-10	
	12	10	■	■		8072172	DHAA-G-R3-12-B20-10	
	16	16	■	■		8071917	DHAA-G-R3-16-B18-10	
	16	25	■	■		8079173	DHAA-G-R3-16-B18-16	
	25	25	■	■		8071956	DHAA-G-R3-25-B18-16	
	25	32	■	■		8079201	DHAA-G-R3-25-B20-32	
	32	32	■	■		8079208	DHAA-G-R3-32-B18-25	
	32	40	■	■		8079212	DHAA-G-R3-32-B20-40	

1) Corrosion resistance class CRC 2 to Festo standard FN 940070
Moderate corrosion stress. Indoor applications in which condensation may occur. External visible parts with primarily decorative requirements for the surface and which are in direct contact with the ambient atmosphere typical for industrial applications.

Angle grippers DHWS

Accessories

FESTO

Adapter kit
DHAA, HAPG, HMSV

Material:
Wrought aluminium alloy
Free of copper and PTFE
RoHS-compliant

 Note
The kit includes the individual mounting interface as well as the necessary mounting material.

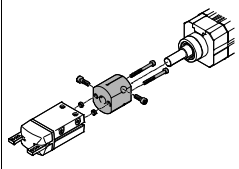
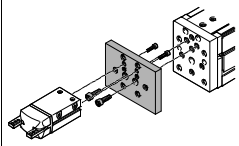
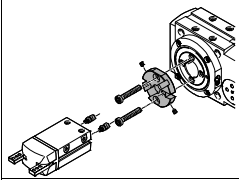
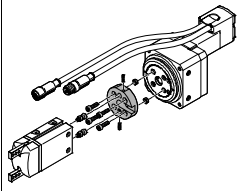
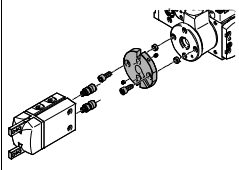
Permissible drive/gripper combinations with adapter kit						Download CAD data → www.festo.com	
Combination	Drive	Gripper	Mounting option		Adapter kit		
			Size	Size	CRC ¹⁾	Part No.	Type
DSL/DHWS	DSL	DHWS			HAPG		
	16	16	■	■	2	163266	HAPG-17
	20	16	■	■		163267	HAPG-18
	20	25	■	■		163268	HAPG-19
	25	25	■	■		163269	HAPG-20
	25	32	■	■		163270	HAPG-21
	32	32	■	■		163271	HAPG-22
EGSL/DHWS	EGSL	DHWS			HMSV		
	35	10	■	■	2	548784	HMSV-54
	45, 55	16	■	■		1088262	HMSV-70
	75	25, 32	■	■		548785	HMSV-55
						548786	HMSV-56
ERMB/DHWS	ERMB	DHWS			HAPG		
	20	25	■	■	2	184479	HAPG-SD2-3
	25	25	■	■		184482	HAPG-SD2-6
	20	32	■	■		184480	HAPG-SD2-4
	25	32	■	■		184483	HAPG-SD2-7
	32	32	■	■		184485	HAPG-SD2-9
	32	40	■	■		184486	HAPG-SD2-10
ERMO/DHWS	ERMO	DHWS			DHAA		
	12	16	■	■	2	8072157	DHAA-G-R3-12-B18-10
	12	10	■	■		8072172	DHAA-G-R3-12-B20-10
	16	16	■	■		8071917	DHAA-G-R3-16-B18-10
	16	25	■	■		8079173	DHAA-G-R3-16-B18-16
	25	25	■	■		8071956	DHAA-G-R3-25-B18-16
	25	32	■	■		8079201	DHAA-G-R3-25-B20-32
	32	32	■	■		8079208	DHAA-G-R3-32-B18-25
	32	40	■	■		8079212	DHAA-G-R3-32-B20-40
EHMB/DHWS	EHMB	DHWS			HAPG		
	20	32	■	■	2	184485	HAPG-SD2-9
	20	40	■	■		184486	HAPG-SD2-10
	25, 32	40	■	■		526027	HAPG-SD2-21

1) Corrosion resistance class CRC 2 to Festo standard FN 940070

Moderate corrosion stress. Indoor applications in which condensation may occur. External visible parts with primarily decorative requirements for the surface and which are in direct contact with the ambient atmosphere typical for industrial applications.

Angle grippers DHWS

Accessories

FESTO

Ordering data						
	For size [mm]	Description	Weight [g]	Part No.	Type	PU ¹⁾
Centring sleeve ZBH Technical data → Internet: zbh						
	10, 16	For centring the gripper during mounting	1	189652	ZBH-5	10
	25		1	186717	ZBH-7	
	32		1	150927	ZBH-9	
	40		1	189653	ZBH-12	

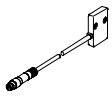

1) Packaging unit

Ordering data						
Type	For size	Weight [g]	Part No.	Type		
Position sensor SMH-S1 Technical data → Internet: smh-s1						
	10	20	175711	SMH-S1-HGW10		

Signal converter SVE4 for position sensor SMH-S1

- Converts analogue signals into switching points
- Switching function freely programmable with teach-in
- Threshold value, hysteresis or window comparator

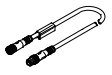
Ordering data						
Type	For size	Input connection	Output connection	Switching output	Weight [g]	Part No. Type
Signal converter SVE4 Technical data → Internet: sve4						
	10	Socket M8x1, 4-pin	Plug M8x1, 4-pin	2x PNP	19	544216 SVE4-HS-R-HM8-2P-M8
				2x NPN		544219 SVE4-HS-R-HM8-2N-M8

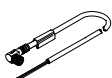
Ordering data – Connecting cables						Technical data → Internet: nebu
	Electrical connection, left	Electrical connection, right	Cable length [m]	Part No.	Type	
Connection between position sensor and signal converter						
	Straight socket, M8x1, 4-pin	Straight plug, M8x1, 4-pin	2.5	554035	NEBU-M8G4-K-2.5-M8G4	
Connection between signal converter and controller						
	Straight socket, M8x1, 4-pin	Cable, open end, 4-wire	2.5	541342	NEBU-M8G4-K-2.5-LE4	
			5	541343	NEBU-M8G4-K-5-LE4	
	Angled socket, M8x1, 4-pin	Cable, open end, 4-wire	2.5	541344	NEBU-M8W4-K-2.5-LE4	
			5	541345	NEBU-M8W4-K-5-LE4	



Angle grippers DHWS

Accessories

FESTO



Proximity sensor for size 16 ... 40



Ordering data – Proximity sensors for T-slot, magneto-resistive						Technical data → Internet: smt	
	Type of mounting	Electrical connection, connection direction	Switching output	Cable length [m]	Part No.	Type	
N/O contact							
	Insertable in the slot lengthwise	Cable, 3-wire, lateral	PNP	2.5	547859	SMT-8G-PS-24V-E-2,5Q-OE	
		Plug M8x1, 3-pin, lateral		0.3	547860	SMT-8G-PS-24V-E-0,3Q-M8D	
		Cable, 3-wire, lateral	NPN	2.5	8065028	SMT-8G-NS-24V-E-2,5Q-OE	
		Plug M8x1, 3-pin, lateral		0.3	8065027	SMT-8G-NS-24V-E-0,3Q-M8D	

Ordering data – Connecting cables					Technical data → Internet: nebu	
	Electrical connection, left	Electrical connection, right	Cable length [m]	Part No.	Type	
	Straight socket, M8x1, 3-pin	Cable, open end, 3-wire	2.5	541333	NEBU-M8G3-K-2.5-LE3	
			5	541334	NEBU-M8G3-K-5-LE3	
	Angled socket, M8x1, 3-pin	Cable, open end, 3-wire	2.5	541338	NEBU-M8W3-K-2.5-LE3	
			5	541341	NEBU-M8W3-K-5-LE3	

Position transmitter

The position transmitter continuously senses the position of the piston.
It has an analogue output with an output signal in proportion to the piston position.

Ordering data – Position transmitters for T-slot							Technical data → Internet: position transmitter		
	For size	Position measuring range	Analogue output		Type of mounting	Electrical connection	Cable length [m]	Part No.	Type
			[V]	[mA]					
	16 ... 40	0 ... 40	0 ... 10	–	Insertable in slot from above	Plug M8x1, 4-pin, in-line	0.3	553744	SMAT-8M-U-E-0,3-M8D
	32, 40	0 ... 50	–	4 ... 20	Insertable in slot from above	Plug M8x1, 4-pin, in-line	0.3	1531265	SDAT-MHS-M50-1L-SA-E-0.3-M8

Ordering data – Connecting cables					Technical data → Internet: nebu	
	Electrical connection, left	Electrical connection, right	Cable length [m]	Part No.	Type	
	Straight socket, M8x1, 4-pin	Cable, open end, 4-wire	2.5	541342	NEBU-M8G4-K-2.5-LE4	
			5	541343	NEBU-M8G4-K-5-LE4	
	Angled socket, M8x1, 4-pin	Cable, open end, 4-wire	2.5	541344	NEBU-M8W4-K-2.5-LE4	
			5	541345	NEBU-M8W4-K-5-LE4	