













Pressure gauges



Pressure gauges

Product range overview

FESTO

Type	Pneumatic connection	Nominal size	Display unit						Red/ green range	→ Page/ Internet	
			Outer scale			Inner scale					
			bar	MPa	psi	bar	MPa	psi			
Pressure gauge MA-...-EN		R $\frac{1}{8}$, R $\frac{1}{4}$, G $\frac{1}{4}$	40	■	-	-	-	-	■	-	3
		G $\frac{1}{4}$	50, 63								
Pressure gauge with red/green range MA-...-RG		R $\frac{1}{8}$	40	■	-	-	-	-	-	■	6
				-	■	-	-	-	-		
				-	-	■	-	-	-		
		R $\frac{1}{4}$	50	■	-	-	-	-	-		
				-	■	-	-	-	-		
Pressure gauge MA		M5	15	■	-	-	-	-	-	-	8
				-	-	■	-	-	-		
			27	■	-	-	-	-	-		
				-	■	-	-	-	-		
		R $\frac{1}{8}$	23, 27	■	-	-	-	-	■		
				-	■	-	-	-	-		
		G $\frac{1}{8}$	40	■	-	-	-	-	■		
				-	■	-	-	-	-		
		G $\frac{1}{4}$	50	■	-	-	-	-	■		
				-	■	-	-	-	-		
		63	■	-	-	-	-	■			
Precision pressure gauge MAP		R $\frac{1}{8}$	40	■	-	-	-	-	■	-	12
Pressure gauge MA-...-QS		QS-4, QS-6, QS-8	15	■	-	-	-	-	-	-	13
Flanged pressure gauge FMA-...-EN		G $\frac{1}{4}$	40, 50, 63	■	-	-	-	-	■	-	14
Flanged pressure gauge FMA		G $\frac{1}{4}$	63	■	-	-	-	-	■	-	16
Precision flanged pressure gauge FMAP		G $\frac{1}{4}$	63	■	-	-	-	-	■	-	17
Pressure gauge PAGN-...-P10		Cartridge 10 mm	26, 40	■	-	-	-	-	■	-	19
				-	-	■	■	-	-		
				-	■	-	-	-	-		
Pressure gauge PAGN		G $\frac{1}{8}$	23	■	-	-	-	-	■	-	21
				-	■	-	-	-	-		
		R $\frac{1}{8}$, G $\frac{1}{8}$	40								23
		G $\frac{1}{4}$	63	-	■	-	■	-	-	-	
Precision pressure gauge PAGN		R $\frac{1}{8}$	40	■	-	-	-	-	■	-	25
				-	■	-	■	-	-		
Flanged pressure gauge PAGN-P		G $\frac{1}{4}$	40, 50, 63	-	■	-	■	-	-	-	27

Pressure gauges MA-EN

Technical data

Function



 - Temperature range
 -20 ... +60 °C



Technical data						
Nominal size	40			50		63
Pneumatic connection	R $\frac{1}{8}$	R $\frac{1}{4}$	G $\frac{1}{4}$	G $\frac{1}{4}$	G $\frac{1}{4}$	
Operating medium	Inert gases Neutral liquids					
Note on operating/pilot medium	No oxygen No acetylene					
Design	Bourdon tube pressure gauge					
Conforms to	EN 837-1					
Type of mounting	Inline installation					
Connection position	Centred, rear side					
Ambient temperature [°C]	-20 ... +60					
Temperature of medium [°C]	-20 ... +60 ¹⁾					
Measurement accuracy class	2.5					
Continuous load factor	0.75					
Intermittent load factor	0.66					
Protection class	IP43					
For MS series service units	MS4	MS4/MS6/MS9/MS12		-	-	
Weight [g]	60	70	70	70	80	

1) With a media temperature below 0 °C, the operating medium should be dry.

Materials						
Nominal size	40			50		63
Pneumatic connection	R $\frac{1}{8}$	R $\frac{1}{4}$	G $\frac{1}{4}$	G $\frac{1}{4}$	G $\frac{1}{4}$	
Housing	only MA-40-10-1/8-EN not MA-40-10-1/8-EN	PBT (colour: black) ABS (colour: black)		-		
Inspection window	PS					
Threaded plug/ materials in contact with the medium	Brass					
Note on materials	RoHS-compliant					

Display range						
Nominal size	40			50		63
Pneumatic connection	R $\frac{1}{8}$	R $\frac{1}{4}$	G $\frac{1}{4}$	G $\frac{1}{4}$	G $\frac{1}{4}$	
[bar]	[psi]					
0 ... 1	0 ... 14.5	-	-	-	-	■
0 ... 2.5	0 ... 36	-	-	-	■	-
0 ... 6	0 ... 87	-	■	■	-	-
0 ... 10	0 ... 145	■	■	■	■	-
0 ... 16	0 ... 232	-	■	■	■	-
0 ... 25	0 ... 360	■	-	■	-	-

Pressure gauges MA-EN

Technical data

FESTO

Dimensions

Download CAD data → www.festo.com

MA-40, R $\frac{1}{8}$

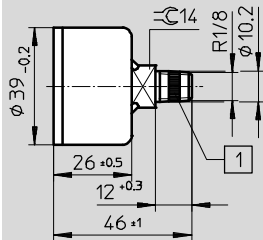

1 PTFE seal with
MA-40-25- $\frac{1}{8}$ -EN

MA-40, R $\frac{1}{4}$

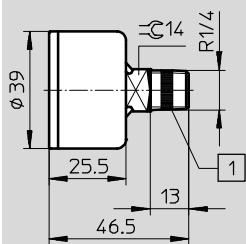

1 PTFE seal

MA-40, G $\frac{1}{4}$

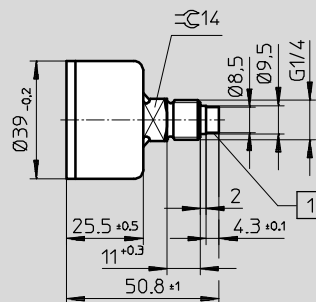

1 With pre-assembled PTFE
sealing ring

MA-50/63, G $\frac{1}{4}$

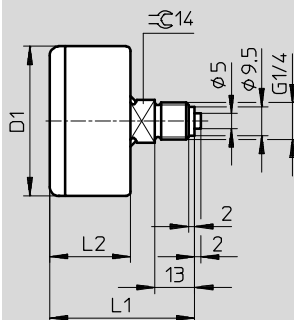

Type	D1 Ø	L1	L2
MA-50	49	47.5	26.5
MA-63	61.5	48.5	27.5

Pressure gauges MA-EN



Technical data

Ordering data						
Nominal size	Pneumatic connection	Operating pressure	Display range		Part No.	Type
			[bar]	[psi]		
40	R ¹ / ₈	0 ... 10 bar	0 ... 10	0 ... 145	162835	MA-40-10- ¹ / ₈ -EN
		0 ... 25 bar	0 ... 25	0 ... 360	526167	MA-40-25- ¹ / ₈ -EN
	R ¹ / ₄	0 ... 6 bar	0 ... 6	0 ... 87	187078	MA-40-6-R ¹ / ₄ -EN
		0 ... 10 bar	0 ... 10	0 ... 145	187079	MA-40-10-R ¹ / ₄ -EN
		0 ... 16 bar	0 ... 16	0 ... 232	187080	MA-40-16-R ¹ / ₄ -EN
	G ¹ / ₄	0 ... 6 bar	0 ... 6	0 ... 87	183899	MA-40-6-G ¹ / ₄ -EN
		0 ... 10 bar	0 ... 10	0 ... 145	183900	MA-40-10-G ¹ / ₄ -EN
		0 ... 16 bar	0 ... 16	0 ... 232	183901	MA-40-16-G ¹ / ₄ -EN
		0 ... 25 bar	0 ... 25	0 ... 360	183902	MA-40-25-G ¹ / ₄ -EN
50	G ¹ / ₄	0 ... 2.5 bar	0 ... 2.5	0 ... 36	162837	MA-50-2,5- ¹ / ₄ -EN
		0 ... 10 bar	0 ... 10	0 ... 145	162838	MA-50-10- ¹ / ₄ -EN
		0 ... 16 bar	0 ... 16	0 ... 232	162839	MA-50-16- ¹ / ₄ -EN
63	G ¹ / ₄	0 ... 1 bar	0 ... 1	0 ... 14.5	162844	MA-63-1- ¹ / ₄ -EN

Pressure gauges MA-RG, with red/green range

Technical data

Function



-  - Temperature range
-20 ... +60 °C



The adjustable red/green range provides additional safety when monitoring compressed air.

With the two red segments above the pressure gauge scale along with the printed green segment it is possible to

individually limit the desired pressure range. This coloured demarcation enables you to recognise immediately

whether or not the pressure is in the permitted tolerance range.

Technical data		
Nominal size	40	50
Pneumatic connection	R $\frac{1}{8}$	R $\frac{1}{4}$
Operating medium	Inert gases Neutral liquids	
Note on operating/pilot medium	No oxygen No acetylene	
Design	Bourdon tube pressure gauge	
Conforms to	EN 837-1	
Type of mounting	Inline installation	
Connection position	Centred, rear side	
Ambient temperature [°C]	-20 ... +60	
Temperature of medium [°C]	-20 ... +60 ¹⁾	
Measurement accuracy class	2.5	
Continuous load factor	0.75	
Intermittent load factor	0.66	
Protection class	IP43	
For MS series service units	MS4	MS4/MS6/MS9/MS12
Weight [g]	60	75

1) With a media temperature below 0 °C, the operating medium should be dry.

Materials	
Housing	ABS (colour: black)
Inspection window	PMMA
Threaded plug/ materials in contact with the medium	Brass
Note on materials	RoHS-compliant

Pressure gauges MA-RG, with red/green range

FESTO

Technical data

Display range		
Nominal size	40	50
Pneumatic connection	R $\frac{1}{8}$	R $\frac{1}{4}$
[bar]		
0 ... 2.5	■	■
0 ... 10	■	■
0 ... 16	■	■
[MPa]		
0 ... 0.25	-	■
0 ... 1	■	■
0 ... 1.6	■	■
[psi]		
0 ... 36	-	■
0 ... 145	■	■
0 ... 232	■	■

Dimensions

Download CAD data → www.festo.com

MA-...-E-RG

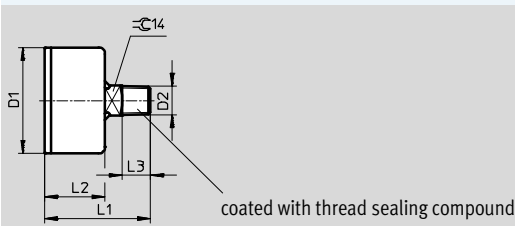

Type	D1 ∅ ±0.5	D2	L1 ±1	L2 ±0.5	L3
MA-40-...-E-RG	39	R $\frac{1}{8}$	46	28	10
MA-50-...-E-RG	49	R $\frac{1}{4}$	49	28	13

Ordering data

Nominal size	Pneumatic connection	Operating pressure	Display range	Part No.	Type
Display unit [bar]					
40	R $\frac{1}{8}$	0 ... 2.5 bar	0 ... 2.5	546963	MA-40-2,5-R $\frac{1}{8}$ -E-RG
		0 ... 10 bar	0 ... 10	525725	MA-40-10-R $\frac{1}{8}$ -E-RG
		0 ... 16 bar	0 ... 16	525726	MA-40-16-R $\frac{1}{8}$ -E-RG
50	R $\frac{1}{4}$	0 ... 2.5 bar	0 ... 2.5	525727	MA-50-2,5-R $\frac{1}{4}$ -E-RG
		0 ... 10 bar	0 ... 10	525728	MA-50-10-R $\frac{1}{4}$ -E-RG
		0 ... 16 bar	0 ... 16	525729	MA-50-16-R $\frac{1}{4}$ -E-RG
Display unit [MPa]					
40	R $\frac{1}{8}$	0 ... 1 MPa	0 ... 1	526778	MA-40-1,0-R $\frac{1}{8}$ -MPA-E-RG
		0 ... 1.6 MPa	0 ... 1.6	526779	MA-40-1,6-R $\frac{1}{8}$ -MPA-E-RG
50	R $\frac{1}{4}$	0 ... 0.25 MPa	0 ... 0.25	526780	MA-50-0,25-R $\frac{1}{4}$ -MPA-E-RG
		0 ... 1 MPa	0 ... 1	526781	MA-50-1,0-R $\frac{1}{4}$ -MPA-E-RG
		0 ... 1.6 MPa	0 ... 1.6	526782	MA-50-1,6-R $\frac{1}{4}$ -MPA-E-RG
Display unit [psi]					
40	R $\frac{1}{8}$	0 ... 145 psi	0 ... 145	526786	MA-40-145-R $\frac{1}{8}$ -PSI-E-RG
		0 ... 232 psi	0 ... 232	526787	MA-40-232-R $\frac{1}{8}$ -PSI-E-RG
50	R $\frac{1}{4}$	0 ... 36 psi	0 ... 36	526788	MA-50-36-R $\frac{1}{4}$ -PSI-E-RG
		0 ... 145 psi	0 ... 145	526789	MA-50-145-R $\frac{1}{4}$ -PSI-E-RG
		0 ... 232 psi	0 ... 232	526790	MA-50-232-R $\frac{1}{4}$ -PSI-E-RG

Pressure gauges MA

Technical data

Function



Temperature range
-20 ... +60 °C

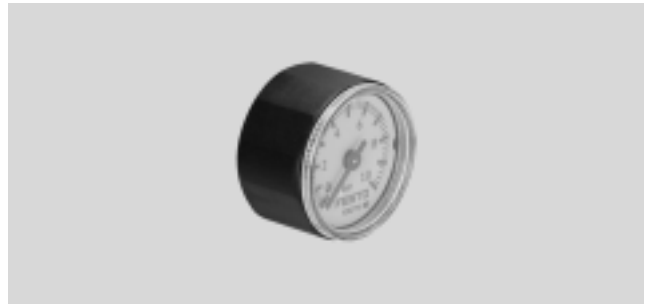

Technical data							
Nominal size	15	23	27	40	50	63	
Pneumatic connection	M5	R $\frac{1}{8}$	M5	R $\frac{1}{8}$	G $\frac{1}{8}$	G $\frac{1}{4}$	G $\frac{1}{4}$
Operating medium	Inert gases						Gaseous media
	Neutral liquids						Fluid media
Note on operating/pilot medium	No oxygen						
	No acetylene						
Design	Bourdon tube pressure gauge without measuring mechanism	Bourdon tube pressure gauge					Capsule pressure gauge
Conforms to	-		-		EN 837-1		EN 837-3
Type of mounting	Inline installation						
Connection position	Centred, rear side						
Ambient temperature [°C]	-20 ... +60		0 ... +60		-20 ... +60		-20 ... +60
Temperature of medium [°C]	-20 ... +60 ¹⁾		0 ... +60		-20 ... +60 ¹⁾		-20 ... +80 ¹⁾
Measurement accuracy class	5	4	4	2.5		1.6	
Continuous load factor	0.75						
Intermittent load factor	0.66	0.6	0.66				0.9
Protection class	IP53	IP44	IP43			IP43	
For D series service units	-	-	MICRO	-	MINI	MIDI/MAXI	-
Weight [g]	10	27	11	8	60	70	180

1) With a media temperature below 0 °C, the operating medium should be dry.

Materials							
Nominal size	15	23	27	40	50	63	
Pneumatic connection	M5	R $\frac{1}{8}$	M5	R $\frac{1}{8}$	G $\frac{1}{8}$	G $\frac{1}{4}$	G $\frac{1}{4}$
Housing	Steel (colour: black)	Brass (colour: black)	PA (colour: black)		ABS (colour: black)		Steel
Inspection window	PC		PS		PS		PMMA
Threaded plug/ materials in contact with the medium	Brass		Brass	PA reinforced	Brass		Brass
Note on materials	RoHS-compliant						

Pressure gauges MA

Technical data

FESTO

Display range								
Nominal size	15	23	27		40	50	63	
Pneumatic connection	M5	R $\frac{1}{8}$	M5	R $\frac{1}{8}$	G $\frac{1}{8}$	G $\frac{1}{4}$	G $\frac{1}{4}$	
[bar]	[psi]							
0 ... 0.25	0 ... 3.6	-	-	-	-	-	-	■
0 ... 6	0 ... 87	-	■	-	-	-	-	-
0 ... 10	0 ... 145	-	■	-	-	■	■	-
0 ... 16	0 ... 232	-	■	-	■	■	■	-
0 ... 25	0 ... 360	-	-	-	■	-	-	-
[bar]								
0 ... 10		■	-	■	-	-	-	-
[MPa]								
0 ... 0.6		-	-	-	-	-	-	-
0 ... 1		-	-	■	-	■	■	-
0 ... 1.6		-	-	-	-	■	■	-
0 ... 2.5		-	-	-	-	-	-	-
[psi]								
0 ... 145		■	-	-	-	-	-	-
0 ... 160		-	-	■	-	-	-	-

Dimensions

Download CAD data → www.festo.com

MA-15

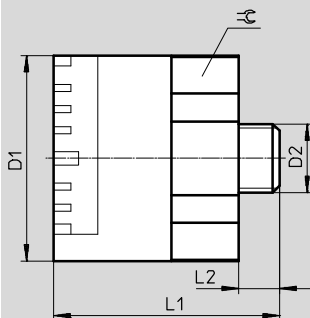

Type	D1 Ø	D2	L1	L2	☞
MA-15	15	M5	16.5	3	14

Pressure gauges MA

Technical data

FESTO

Dimensions

Download CAD data → www.festo.com

MA-23

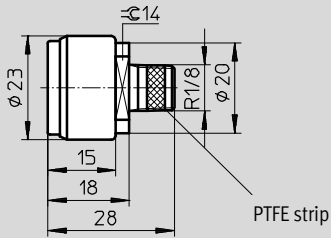

MA-27, M5

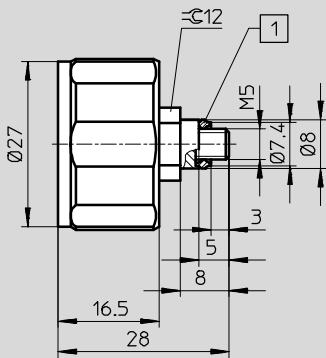

MA-27, R $\frac{1}{8}$

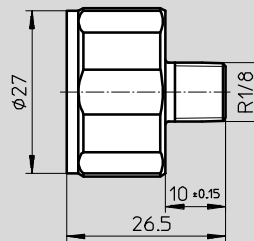

1 With pre-assembled polyamide sealing ring

MA-40, G $\frac{1}{8}$

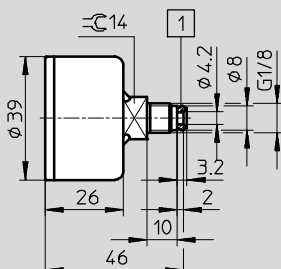

1 With pre-assembled aluminium sealing ring with MA-40-...-G $\frac{1}{8}$

MA-50

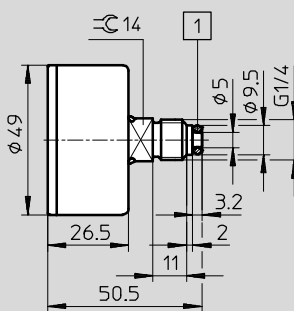

MA-63

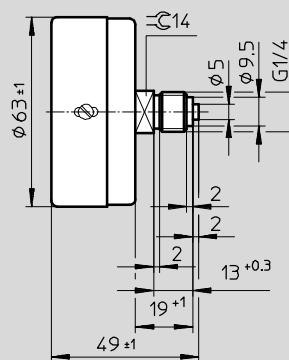

1 With pre-assembled aluminium sealing ring with MA-50-...-G $\frac{1}{4}$

Pressure gauges MA

Technical data

Ordering data						
Nominal size	Pneumatic connection	Operating pressure	Display range		Part No.	Type
			[bar]	[psi]		
23	R1/8	0 ... 6 bar	0 ... 6	0 ... 87	183896	MA-23-6-R1/8
		0 ... 10 bar	0 ... 10	0 ... 145	183897	MA-23-10-R1/8
		0 ... 16 bar	0 ... 16	0 ... 232	183898	MA-23-16-R1/8
27	R1/8	0 ... 16 bar	0 ... 16	0 ... 232	541733	MA-27-16-R1/8
		0 ... 25 bar	0 ... 25	0 ... 360	541734	MA-27-25-R1/8
40	G1/8	0 ... 10 bar	0 ... 10	0 ... 145	359874	MA-40-10-1/8
		0 ... 16 bar	0 ... 16	0 ... 232	345395	MA-40-16-1/8
50	G1/4	0 ... 10 bar	0 ... 10	0 ... 145	359873	MA-50-10-1/4
		0 ... 16 bar	0 ... 16	0 ... 232	356759	MA-50-16-1/4
63	G1/4	0 ... 0.25 bar	0 ... 0.25	0 ... 3.6	7169	MA-63-0,25

Ordering data						
Nominal size	Pneumatic connection	Operating pressure	Display range		Part No.	Type
			[bar]	[psi]		
Display unit [bar]						
15	M5	0 ... 10 bar	0 ... 10		132340	MA-15-10-M5
27	M5	0 ... 10 bar	0 ... 10		526323	MA-27-10-M5
Display unit [MPa]						
27	M5	0 ... 1 MPa	0 ... 1		526324	MA-27-1,0-M5-MPA
40	G1/8	0 ... 1 MPa	0 ... 1		192732	MA-40-1-G1/8-MPA
		0 ... 1.6 MPa	0 ... 1.6		192733	MA-40-1,6-G1/8-MPA
50	G1/4	0 ... 1 MPa	0 ... 1		192734	MA-50-1-G1/4-MPA
		0 ... 1.6 MPa	0 ... 1.6		192735	MA-50-1,6-G1/4-MPA
Display unit [psi]						
15	M5	0 ... 145 psi	0 ... 145		132341	MA-15-145-M5-PSI
27	M5	0 ... 160 psi	0 ... 160		527405	MA-27-160-M5-PSI

Precision pressure gauges MAP

FESTO

Technical data

Function

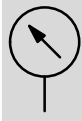

Temperature range
-20 ... +60 °C



Technical data	
Nominal size	40
Pneumatic connection	R $\frac{1}{8}$
Operating medium	Inert gases Neutral liquids
Note on operating/pilot medium	No oxygen No acetylene
Design	Bourdon tube pressure gauge
Conforms to	EN 837-1
Type of mounting	Inline installation
Connection position	Centred, rear side
Ambient temperature [°C]	-20 ... +60
Temperature of medium [°C]	-20 ... +60 ¹⁾
Measurement accuracy class	1.6
Continuous load factor	0.75
Intermittent load factor	0.66
Protection class	IP43
Weight [g]	60

1) With a media temperature below 0 °C, the operating medium should be dry.

Materials	
Housing	PBT (colour: black)
Inspection window	PS
Threaded plug/ materials in contact with the medium	Brass
Note on materials	RoHS-compliant

Dimensions Download CAD data → www.festo.com

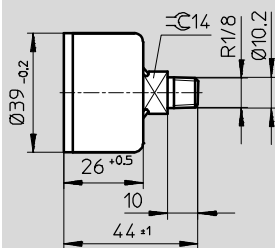

Ordering data						
Nominal size	Pneumatic connection	Operating pressure	Display range		Part No.	Type
			[bar]	[psi]		
40	R $\frac{1}{8}$	0 ... 1 bar	0 ... 1	0 ... 15	161126	MAP-40-1- $\frac{1}{8}$ -EN
		0 ... 4 bar	0 ... 4	0 ... 58	162842	MAP-40-4- $\frac{1}{8}$ -EN
		0 ... 6 bar	0 ... 6	0 ... 87	161127	MAP-40-6- $\frac{1}{8}$ -EN
		0 ... 16 bar	0 ... 16	0 ... 232	161128	MAP-40-16- $\frac{1}{8}$ -EN

Pressure gauges MA-QS

Technical data

Function



-  - Temperature range
-20 ... +60 °C



Technical data			
Nominal size	15		
Pneumatic connection	QS-4	QS-6	QS-8
Operating medium	Inert gases Neutral liquids		
Note on operating/pilot medium	No oxygen No acetylene		
Design	Bourdon tube pressure gauge without measuring mechanism		
Type of mounting	Inline installation		
Connection position	Centred, rear side		
Ambient temperature [°C]	-20 ... +60		
Temperature of medium [°C]	-20 ... +60		
Measurement accuracy class	5		
Continuous load factor	0.75		
Intermittent load factor	0.66		
Protection class	IP53		
Weight [g]	10		

Materials	
Housing	Steel (colour: black)
Inspection window	PC
Threaded plug/ materials in contact with the medium	Brass
Note on materials	RoHS-compliant

Dimensions Download CAD data → www.festo.com

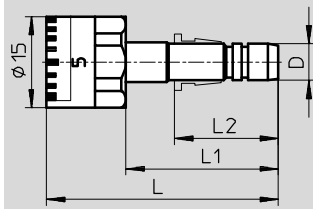

Dimensions and ordering data								
Nominal size	Pneumatic connection D	L	L1	L2	Operating pressure	Display range	Part No.	Type
						[bar]		
15	QS-4	36	23	15	0 ... 10 bar	0 ... 10	153383	MA-15-10-QS-4
	QS-6	38	25	17	0 ... 10 bar	0 ... 10	153384	MA-15-10-QS-6
	QS-8	34	21	18.5	0 ... 10 bar	0 ... 10	153385	MA-15-10-QS-8

Flanged pressure gauges FMA-EN

Technical data

Function



 Temperature range
 -20 ... +60 °C



Technical data			
Nominal size	40	50	63
Pneumatic connection	G $\frac{1}{4}$	G $\frac{1}{4}$	G $\frac{1}{4}$
Operating medium	Inert gases		
	Neutral fluids		
Note on operating/pilot medium	No oxygen		
	No acetylene		
Design	Bourdon tube pressure gauge		
Conforms to	EN 837-1		
Type of mounting	Front panel mounting		
Connection position	Centred, rear side		
Ambient temperature [°C]	-20 ... +60		
Temperature of medium [°C]	-20 ... +60 ¹⁾		
Measurement accuracy class	2.5		
Continuous load factor	0.75		
Intermittent load factor	0.66		
Protection class	IP43		
Weight [g]	80	100	120

1) With a media temperature below 0 °C, the operating medium should be dry.

Materials	
Housing	ABS (colour: black)
Inspection window	SAN
Mounting ring	Steel
Threaded plug/ materials in contact with the medium	Brass
Note on materials	RoHS-compliant

Display range			
Nominal size	40	50	63
Pneumatic connection	G $\frac{1}{4}$	G $\frac{1}{4}$	G $\frac{1}{4}$
[bar]	[psi]		
0 ... 2.5	0 ... 36	-	■
0 ... 10	0 ... 145	■	■
0 ... 16	0 ... 232	■	■

Flanged pressure gauges FMA-EN

Technical data

FESTO

Dimensions

Download CAD data → www.festo.com

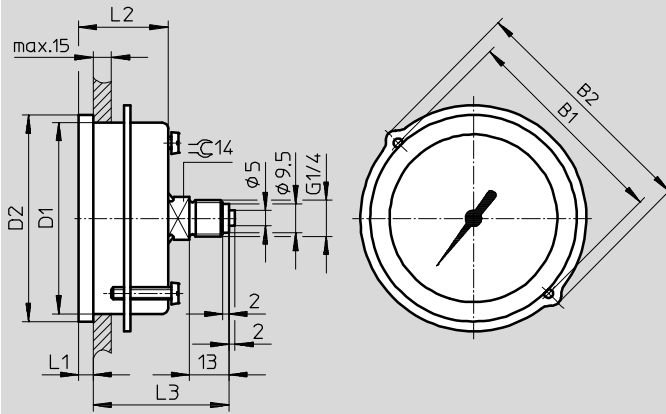

Type	B1	B2	D1 Ø	D2 Ø	L1	L2	L3
FMA-40	48	56	40	45	4.5	26.5	43
FMA-50	57	66	49.5	54	4.5	26.8	43.3
FMA-63	70	79	63	68	4.8	29.5	42.5

Ordering data

Nominal size	Pneumatic connection	Operating pressure	Display range		Part No.	Type
			[bar]	[psi]		
40	G1/4	0 ... 10 bar	0 ... 10	0 ... 145	159596	FMA-40-10-1/4-EN
		0 ... 16 bar	0 ... 16	0 ... 232	159597	FMA-40-16-1/4-EN
50	G1/4	0 ... 2.5 bar	0 ... 2.5	0 ... 36	159598	FMA-50-2,5-1/4-EN
		0 ... 10 bar	0 ... 10	0 ... 145	159599	FMA-50-10-1/4-EN
		0 ... 16 bar	0 ... 16	0 ... 232	159600	FMA-50-16-1/4-EN
63	G1/4	0 ... 2.5 bar	0 ... 2.5	0 ... 36	159601	FMA-63-2,5-1/4-EN
		0 ... 10 bar	0 ... 10	0 ... 145	159602	FMA-63-10-1/4-EN
		0 ... 16 bar	0 ... 16	0 ... 232	159603	FMA-63-16-1/4-EN

Flanged pressure gauges FMA

FESTO

Technical data

Function



-  - Temperature range
-20 ... +60 °C



Technical data	
Nominal size	63
Pneumatic connection	G $\frac{1}{4}$
Operating medium	Gaseous media
	Fluid media
Note on operating/pilot medium	No oxygen
	No acetylene
Design	Capsule pressure gauge
Conforms to	EN 837-3
Type of mounting	Front panel mounting
Connection position	Centred, rear side
Ambient temperature [°C]	-20 ... +60
Temperature of medium [°C]	-20 ... +80
Measurement accuracy class	1.6
Continuous load factor	0.75
Intermittent load factor	0.9
Protection class	IP43
Weight [g]	120

Materials	
Housing	Steel
Inspection window	PMMA
Mounting ring/screws	Steel
Threaded plug	Brass

Dimensions Download CAD data → www.festo.com

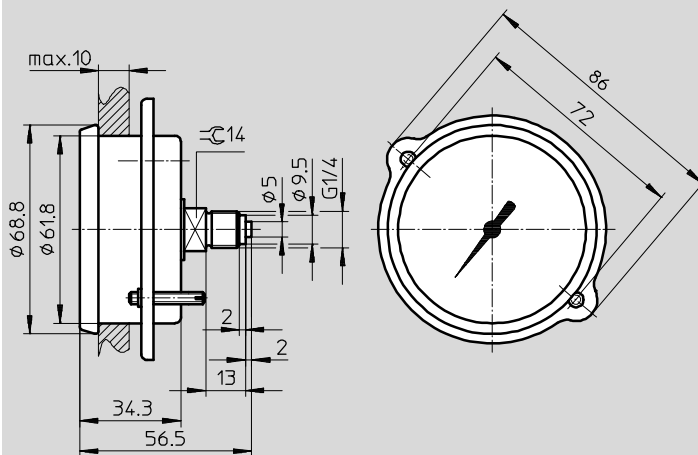

Ordering data						
Nominal size	Pneumatic connection	Operating pressure	Display range		Part No.	Type
			[bar]	[psi]		
63	G $\frac{1}{4}$	0 ... 0.25 bar	0 ... 0.25	0 ... 3.6	225783	FMA-63-0,25-C

Precision flanged pressure gauges FMAP

Technical data

Function



 Temperature range
 -20 ... +60 °C



Technical data	
Nominal size	63
Pneumatic connection	G $\frac{1}{4}$
Operating medium	Inert gases Neutral liquids
Note on operating/pilot medium	No oxygen No acetylene
Design	Bourdon tube pressure gauge
Conforms to	EN 837-1
Type of mounting	Front panel mounting
Connection position	Centred, rear side
Ambient temperature [°C]	-20 ... +60
Temperature of medium [°C]	-20 ... +60 ¹⁾
Measurement accuracy class	1.0
Continuous load factor	0.75
Intermittent load factor	0.66
Protection class	IP43
Weight [g]	120

1) With a media temperature below 0 °C, the operating medium should be dry.

Materials	
Housing	ABS (colour: black)
Inspection window	SAN
Mounting ring	Steel
Threaded plug/ materials in contact with the medium	Brass
Note on materials	RoHS-compliant

Dimensions Download CAD data → www.festo.com

Precision flanged pressure gauges FMAP

FESTO

Technical data

Ordering data						
Nominal size	Pneumatic connection	Operating pressure	Display range		Part No.	Type
			[bar]	[psi]		
63	G ¹ / ₄	0 ... 1 bar	0 ... 1	0 ... 15	161129	FMAP-63-1- ¹ / ₄ -EN
		0 ... 4 bar	0 ... 4	0 ... 58	162843	FMAP-63-4- ¹ / ₄ -EN
		0 ... 6 bar	0 ... 6	0 ... 87	161130	FMAP-63-6- ¹ / ₄ -EN
		0 ... 16 bar	0 ... 16	0 ... 232	161131	FMAP-63-16- ¹ / ₄ -EN

Pressure gauges PAGN-...-P10

Technical data

Function



- Temperature range
 -20 ... +60 °C



Technical data		
Nominal size	26	40
Pneumatic connection	Cartridge 10 mm	Cartridge 10 mm
Operating medium	Inert gases Neutral liquids	
Note on operating/pilot medium	No oxygen No acetylene	
Design	Bourdon tube pressure gauge	
Conforms to	-	EN 837-1
Type of mounting	Inline installation	
Connection position	Centred, rear side	
Ambient temperature [°C]	-20 ... +60	
Temperature of medium [°C]	-20 ... +60 ¹⁾	
Measurement accuracy class	4.0	2.5
Continuous load factor	0.75	
Intermittent load factor	0.66	
Protection class	IP43 NEMA 4 (with outer scale in bar only)	
Weight [g]	15	50

1) With a media temperature below 0 °C, the operating medium should be dry.

Materials		
Nominal size	26	40
Housing	PA (colour: black)	ABS (colour: black)
Inspection window	PS	
Threaded plug/ materials in contact with the medium	Brass	
Note on materials	RoHS-compliant	

Dimensions

Download CAD data → www.festo.com

PAGN-26-...-P10

PAGN-40-...-P10

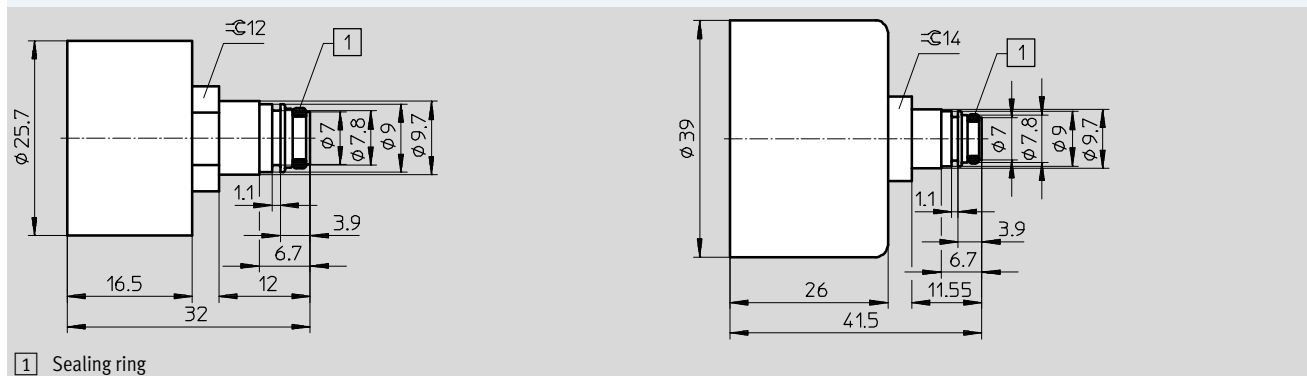

Pressure gauges PAGN-...-P10

Technical data

Ordering data						
Nominal size	Pneumatic connection	Operating pressure	Display range		Part No.	Type
			Outer scale	Inner scale		
Outer scale in bar, inner scale in psi						
26	Cartridge 10 mm	0 ... 10 bar	0 ... 10 bar	0 ... 145 psi	543488	PAGN-26-10-P10
		0 ... 16 bar	0 ... 16 bar	0 ... 232 psi	543487	PAGN-26-16-P10
40	Cartridge 10 mm	0 ... 10 bar	0 ... 10 bar	0 ... 145 psi	548009	PAGN-40-10-P10
		0 ... 16 bar	0 ... 16 bar	0 ... 232 psi	548010	PAGN-40-16-P10
Outer scale in psi, inner scale in bar						
26	Cartridge 10 mm	0 ... 145 psi	0 ... 145 psi	0 ... 10 bar	563732	PAGN-26-145P-P10
		0 ... 232 psi	0 ... 232 psi	0 ... 16 bar	563731	PAGN-26-232P-P10
40	Cartridge 10 mm	0 ... 145 psi	0 ... 145 psi	0 ... 10 bar	563734	PAGN-40-145P-P10
		0 ... 232 psi	0 ... 232 psi	0 ... 16 bar	563733	PAGN-40-232P-P10
Outer scale in MPa						
26	Cartridge 10 mm	0 ... 1 MPa	0 ... 1 MPa	–	563736	PAGN-26-1M-P10
		0 ... 1.6 MPa	0 ... 1.6 MPa	–	563735	PAGN-26-1.6M-P10
40	Cartridge 10 mm	0 ... 1 MPa	0 ... 1 MPa	–	563738	PAGN-40-1M-P10
		0 ... 1.6 MPa	0 ... 1.6 MPa	–	563737	PAGN-40-1.6M-P10

Pressure gauges PAGN

Technical data

Function



 Temperature range
-5 ... +50 °C



Technical data	
Nominal size	23
Pneumatic connection	G $\frac{1}{8}$ with sealing ring
Operating medium	Inert gases Neutral liquids
Note on operating/pilot medium	No oxygen No acetylene
Design	Bourdon tube pressure gauge
Type of mounting	Inline installation
Connection position	Centred, rear side
Ambient temperature [°C]	-5 ... +50
Temperature of medium [°C]	-5 ... +50 ¹⁾
Storage temperature [°C]	-5 ... +50
Measurement accuracy class	4
Continuous load factor	0.75
Intermittent load factor	0.6
Protection class	IP44
Weight [g]	6

1) With a media temperature below 0 °C, the operating medium should be dry.

Materials	
Housing	ABS (colour: black)
Inspection window	PMMA
Threaded plug	ABS reinforced
Materials in contact with the medium	ABS reinforced, brass
Note on materials	RoHS-compliant

Dimensions Download CAD data → www.festo.com

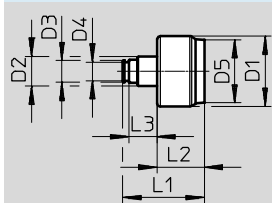

D1	D2	D3	D4	D5	L1	L2	L3
∅		∅	∅	∅			
23	G $\frac{1}{8}$	7.1	6.2 ±0.05	20.8	26.8	15.5	9.3

Pressure gauges PAGN

Technical data

Ordering data					
Nominal size	Pneumatic connection	Operating pressure	Display range		Part No. Type
			Outer scale	Inner scale	
23	G ¹ / ₈ with sealing ring	0 ... 10 bar	0 ... 10 bar	0 ... 145 psi	8088991 PAGN-23-10-G18S
		0 ... 1 MPa	0 ... 1 MPa	–	8088992 PAGN-23-1M-G18S

Pressure gauges PAGN

Technical data

Function



-  - Temperature range
-20 ... +60 °C



Technical data			
Nominal size	40		63
Pneumatic connection	R $\frac{1}{8}$	G $\frac{1}{8}$	G $\frac{1}{4}$
Operating medium	Inert gases Neutral liquids		
Note on operating/pilot medium	No oxygen No acetylene		
Design	Bourdon tube pressure gauge		
Conforms to	EN 837-1		
Type of mounting	Inline installation		
Connection position	Centred, rear side		
Ambient temperature [°C]	-20 ... +60		
Temperature of medium [°C]	-20 ... +60 ¹⁾		
Storage temperature [°C]	-40 ... +70		
Measurement accuracy class	1.6	2.5	1.6
Continuous load factor	0.75		
Intermittent load factor	0.66		
Protection class	IP43		
Weight [g]	60	60	220

1) With a media temperature below 0 °C, the operating medium should be dry.

Materials	
Housing	ABS (colour: black)
Inspection window	PS
Threaded plug/ materials in contact with the medium	Brass
Note on materials	RoHS-compliant

Pressure gauges PAGN

Technical data

FESTO

Dimensions Download CAD data → www.festo.com

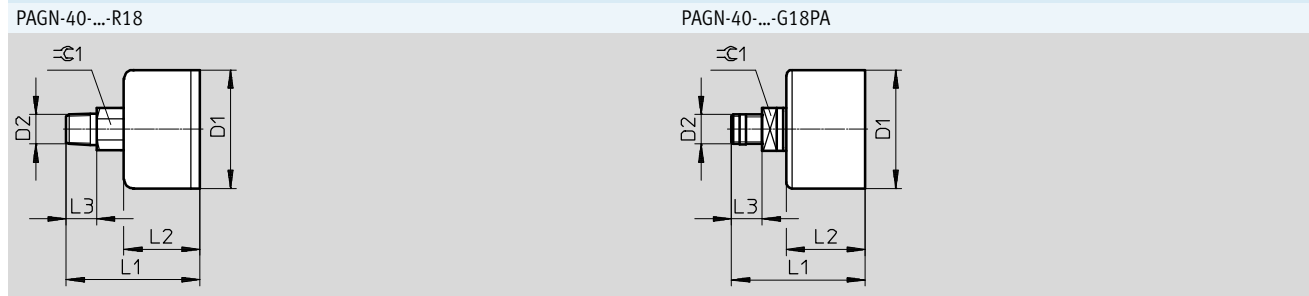

Type	D1 ∅	D2	L1	L2	L3	≈ 1
PAGN-40-...-R18	39	R $\frac{1}{8}$	44	25	10	14
PAGN-40-...-G18PA		G $\frac{1}{8}$		26		

Dimensions Download CAD data → www.festo.com

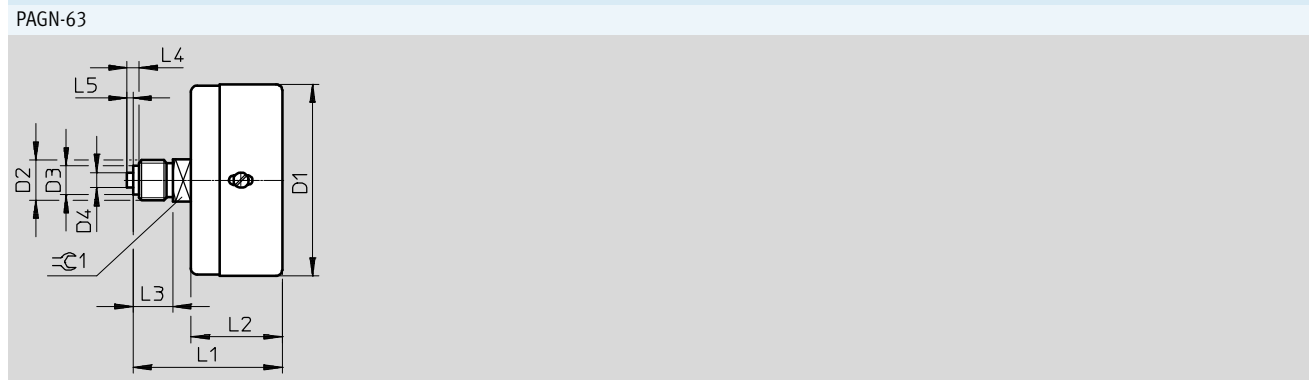

Type	D1 ∅	D2	D3 ∅	D4 ∅	L1	L2	L3	L4	L5	≈ 1
PAGN-63-...-G14	63	G $\frac{1}{4}$	9.5	5	49	30	13	4	2	14

Ordering data

Nominal size	Pneumatic connection	Operating pressure	Display range		Part No.	Type
			Outer scale	Inner scale		
Outer scale in MPa, inner scale in bar						
40	R $\frac{1}{8}$	0 ... 0.4 MPa	0 ... 0.4 MPa	0 ... 4 bar	8037010	PAGN-40-0.4M-R18-1.6
		0 ... 0.6 MPa	0 ... 0.6 MPa	0 ... 6 bar	8037011	PAGN-40-0.6M-R18-1.6
		0 ... 1.6 MPa	0 ... 1.6 MPa	0 ... 16 bar	8037012	PAGN-40-1.6M-R18-1.6
	G $\frac{1}{8}$	0 ... 1 MPa	0 ... 1 MPa	0 ... 10 bar	8037109	PAGN-40-1M-G18PA
63	G $\frac{1}{4}$	0 ... 0.025 MPa	0 ... 0.025 MPa	0 ... 0.25 bar	8036756	PAGN-63-0.025M-G14-1.6

1) With pre-assembled aluminium sealing ring

Precision pressure gauges PAGN

Technical data

Function



 - Temperature range
 -20 ... +60 °C



Technical data	
Nominal size	40
Pneumatic connection	R1/8
Operating medium	Inert gases Neutral liquids
Note on operating/pilot medium	No oxygen No acetylene
Design	Bourdon tube pressure gauge
Conforms to	EN 837-1
Type of mounting	Inline installation
Connection position	Centred, rear side
Ambient temperature [°C]	-20 ... +60
Temperature of medium [°C]	-20 ... +60 ¹⁾
Storage temperature [°C]	-40 ... +70
Measurement accuracy class	1.6
Continuous load factor	0.75
Intermittent load factor	0.66
Protection class	IP43
Weight [g]	60

1) With a media temperature below 0 °C, the operating medium should be dry.

Materials	
Housing	PBT (colour: black)
Inspection window	PS
Threaded plug/ materials in contact with the medium	Brass
Note on materials	RoHS-compliant

Dimensions Download CAD data → www.festo.com

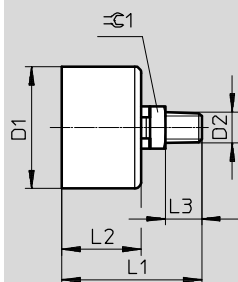

D1	D2	L1	L2	L3	⌀1
39 +0.1/-0.2	R1/8	44	25 +0.5	10	14

Precision pressure gauges PAGN

Technical data

Ordering data					
Nominal size	Pneumatic connection	Operating pressure	Display range		Part No. Type
			Outer scale	Inner scale	
Outer scale in bar, inner scale in psi					
40	R1/8	0 ... 10 bar	0 ... 10 bar	0 ... 145 psi	2849914 PAGN-40-10-R18-1.6
Outer scale in MPa, inner scale in bar					
40	R1/8	0 ... 1 MPa	0 ... 1 MPa	0 ... 10 bar	2849916 PAGN-40-1M-R18-1.6

Flanged pressure gauges PAGN-P

FESTO

Technical data

Function



 Temperature range
 -20 ... +60 °C



Technical data			
Nominal size	40	50	63
Pneumatic connection	G $\frac{1}{4}$	G $\frac{1}{4}$	G $\frac{1}{4}$
Operating medium	Inert gases Neutral fluids		
Note on operating/pilot medium	No oxygen No acetylene		
Design	Bourdon tube pressure gauge		
Conforms to	EN 837-1		
Type of mounting	Front panel mounting		
Connection position	Centred, rear side		
Ambient temperature [°C]	-20 ... +60		
Temperature of medium [°C]	-20 ... +60 ¹⁾		
Storage temperature [°C]	-40 ... +70		
Measurement accuracy class	-	1 (PAGN-P-63-...-G14-1)	
	2.5	2.5 (PAGN-P-63-...-G14)	
Continuous load factor	0.75		
Intermittent load factor	0.66		
Protection class	IP43		
Weight [g]	80	100	120

1) With a media temperature below 0 °C, the operating medium should be dry.

Materials	
Housing	ABS (colour: black)
Inspection window	SAN
Mounting ring/screws	Steel
Threaded plug/ materials in contact with the medium	Brass
Note on materials	RoHS-compliant

Flanged pressure gauges PAGN-P

Technical data

FESTO

Dimensions Download CAD data → www.festo.com

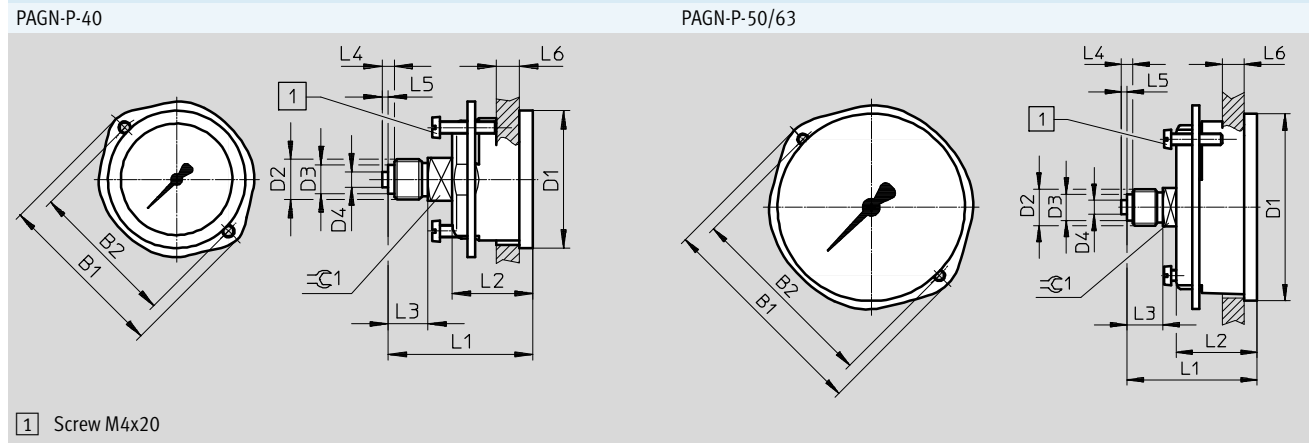

Type	B1	B2	D1 ∅	D2	D3 ∅	D4 ∅	L1	L2	L3	L4	L5	L6		≈C 1
												min.	max.	
PAGN-P-40	56	48	45	G1/4	9.5	5	47.5	26.5	13	4	2	0	15	14
PAGN-P-50	66	57	54				47.8	26.8				0	15	
PAGN-P-63	79	70	68				47.3	29.5				0	15	

Ordering data						
Nominal size	Pneumatic connection	Operating pressure	Measurement accuracy class	Display range		Part No. Type
				Outer scale	Inner scale	
40	G1/4	0 ... 1 MPa	2.5	0 ... 1 MPa	0 ... 10 bar	8037006 PAGN-P-40-1M-G14
		0 ... 1.6 MPa	2.5	0 ... 1.6 MPa	0 ... 16 bar	8037007 PAGN-P-40-1.6M-G14
50	G1/4	0 ... 1 MPa	2.5	0 ... 1 MPa	0 ... 10 bar	8037008 PAGN-P-50-1M-G14
		0 ... 1.6 MPa	2.5	0 ... 1.6 MPa	0 ... 16 bar	8037009 PAGN-P-50-1.6M-G14
63	G1/4	0 ... 0.1 MPa	1	0 ... 0.1 MPa	0 ... 1 bar	8037002 PAGN-P-63-0.1M-G14-1
		0 ... 0.4 MPa	1	0 ... 0.4 MPa	0 ... 4 bar	8037003 PAGN-P-63-0.4M-G14-1
		0 ... 0.6 MPa	1	0 ... 0.6 MPa	0 ... 6 bar	8037004 PAGN-P-63-0.6M-G14-1
		0 ... 1 MPa	2.5	0 ... 1 MPa	0 ... 10 bar	8037000 PAGN-P-63-1M-G14
		0 ... 1.6 MPa	2.5	0 ... 1.6 MPa	0 ... 16 bar	8037001 PAGN-P-63-1.6M-G14
			1	0 ... 1.6 MPa	0 ... 16 bar	8037005 PAGN-P-63-1.6M-G14-1