

# XOMOX<sup>®</sup>

brands you trust.

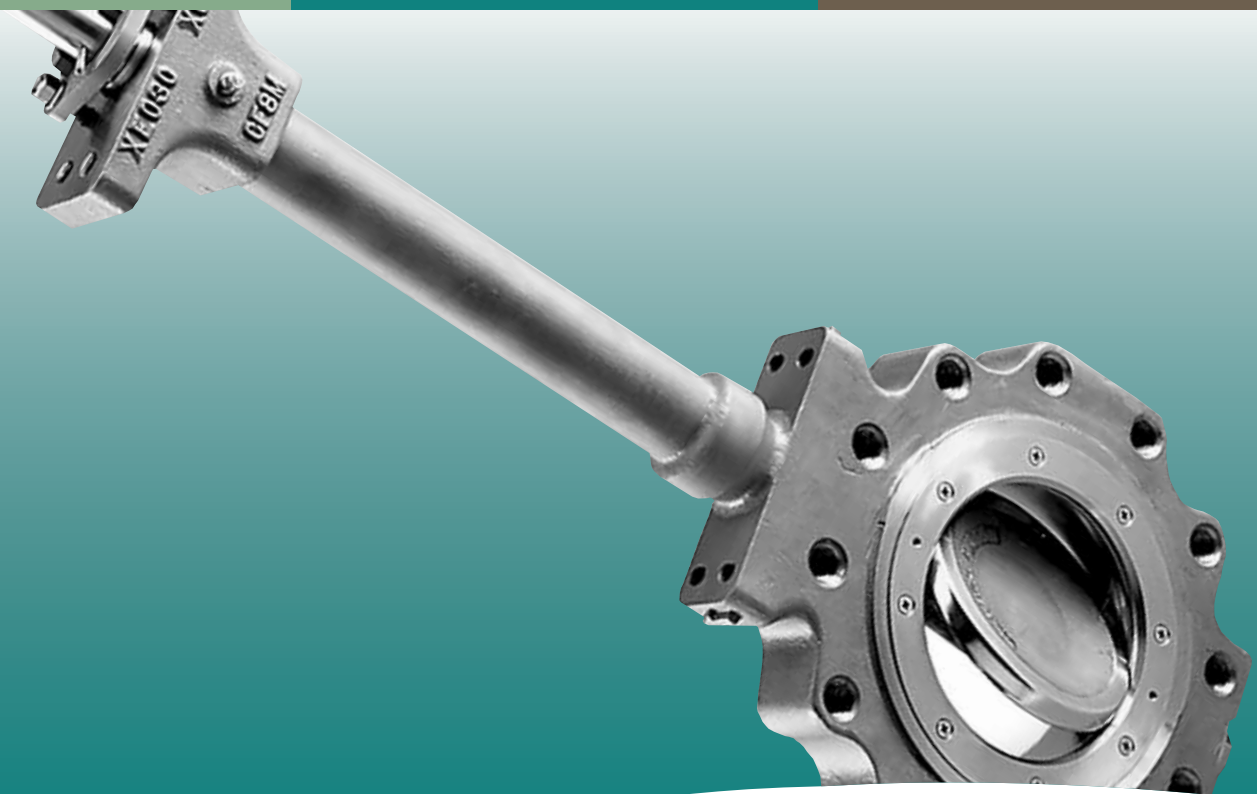

**CRANE**<sup>®</sup>

ChemPharma Flow Solutions

Tuflin<sup>®</sup> Cryogenic Butterfly Valves

[www.cranepharmasolutions.com](http://www.cranepharmasolutions.com)

## Cryogenic by design.

Tufline Cryogenic Butterfly valves are specifically designed for sub-zero line temperature services. These valves handle cryogenic fluids efficiently and reliably with minimum maintenance requirements.

## Compact for better temperature control.

The compact size of the wafer and lug style valves permits minimum temperature stabilization times on either line heat-up or cool-down.

## Application flexibility.

The stainless steel materials of construction provide for maximum service flexibility and media applications.

## Designed for actuation and easy adjustment.

Integrally welded shaft and bonnet extensions enable valve actuators to be mounted well above pipeline insulation and provides for easy adjustment of the stem packing gland pressure.

## Patented and proven performance.

Tufline Cryogenic valves utilize a variation of the patented fire tested seat design, combining a 316 stainless steel seat ring with a PCTFE plastic insert, designated as the CT4 seat.

## Choose semi-cryogenic or full-cryogenic configurations.

For applications from -50°F down to -180°F, the semi-cryogenic valve with a standard 8" extension is recommended.

For applications from -180°F to -425°F, the full-cryogenic valve with a longer extension is available. The extension length to be mutually agreed upon by the customer and Xomox.

### Available configurations:

- Semi-cryogenic and full-cryogenic.
- Sizes: 3" to 24".
- ANSI Classes: 150, 300, & 600.

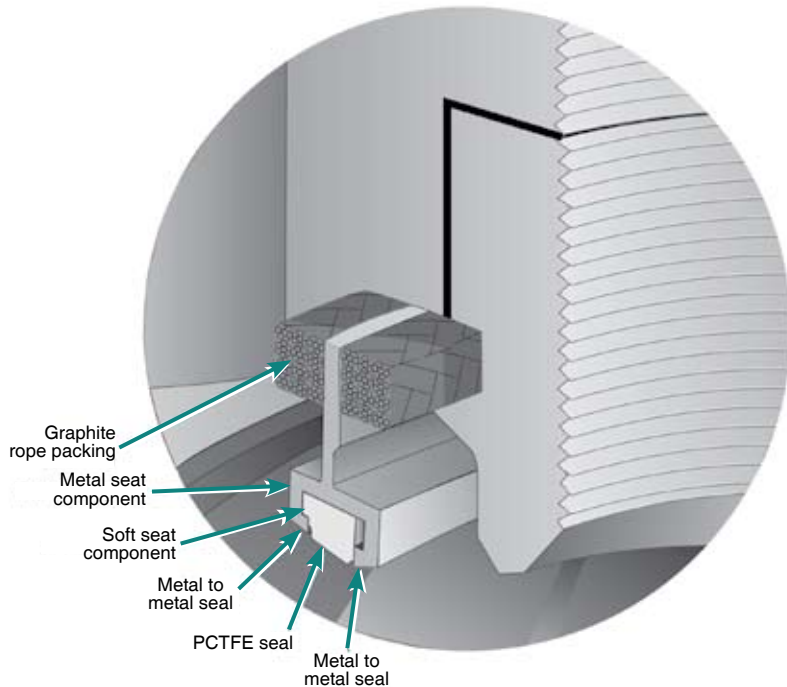

## For assured sealing . . . the Tufline CT4 Seat.

At cryogenic temperatures all plastic seats have a tendency to embrittle and crack.

The Tufline CT4 cryogenic seat combines PCTFE and metal

sealing elements and establishes both a PCTFE to metal and a dual metal to metal seal.

The metal carrier not only enhances the reliability of the seal but also provides additional support for the PCTFE component.

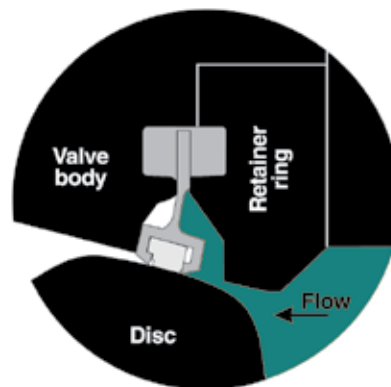

### Normal operation - (right to left flow)

This unique seat is designed for bi-directional flow control. As pressure increases, the seat shifts axially in the direction of the flow. This tightens the seat contact with the disc for sure sealing.

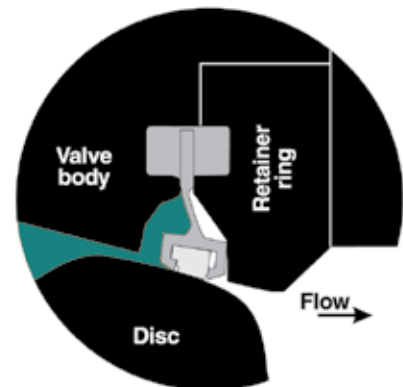

### Normal operation - (left to right flow)

Both the metal seat and the PCTFE seat are in tight contact with the disc. As line pressure increases, the seal tightens, axially.

### Technical Description

PolyChloroTriFluoroEthylene is a fluorocarbon-based polymer and is commonly abbreviated PCTFE. The Kel-F® brand is a registered trademark of 3M, but they discontinued production in 1995. The only remaining brand, Neoflon®, is made by Daikin Industries of Japan. This PCTFE resin has the same chemical structure and properties as the original Kel-F® brand material.

© Copyright Xomox Corporation 2001, 2009.  
All rights reserved. Xomox®, Tufline®, and Matryx® are registered trademarks of Xomox Corporation.

# Tufline Semi-Cryogenic and Cryogenic High Performance Butterfly Valves

## Cv factors for Valve Sizing

Use the Cv factors listed on page 15 of Tufline High Performance Butterfly Valve brochure 329389.

## Breakaway and Seating Torque Values for Actuator Sizing

Add 30% to the Fire Tested and High Temperature seat torque values listed on pages 18 and 19 of Tufline High Performance Butterfly Valve brochure 32989.



# Seat Performance Data

Seat Type	Maximum Temperature	Minimum Temperature	Test Leak Rate (Ambient)	Test Leak Rate (Cryogenic Service)
CT4	+280°F	-425°F	Class VI	10% of Class IV

**Class 150 Valves**

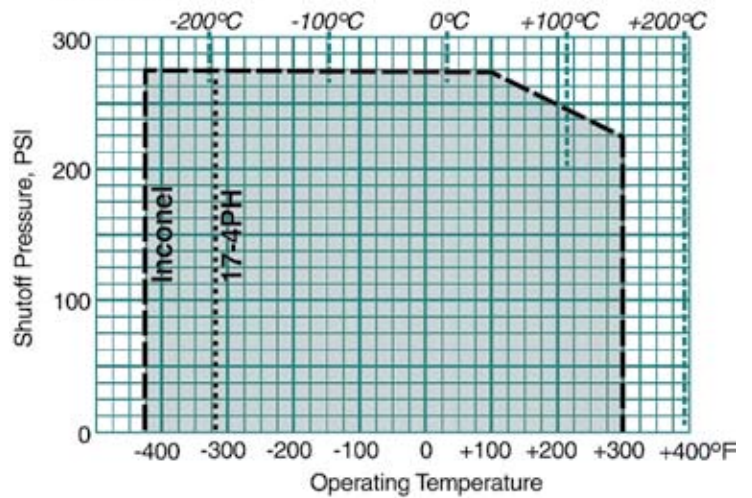

**Class 300 Valves**

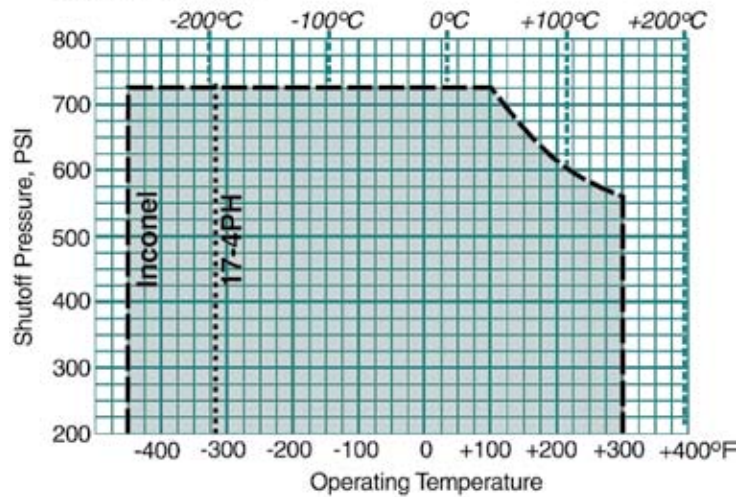

**Class 600 Valves**

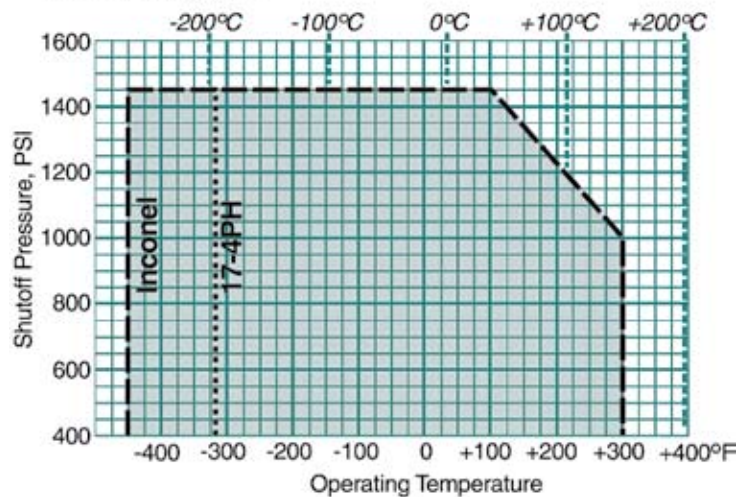

# Dimensions

## Letter designations for valve dimensions:

- A - Face-to-face thickness of valve
- H - Waterway diameter
- L - Number of flange bolts
- LE - Width of lug body
- LG - Centerline of waterway to bottom of valve (lug style)
- M - Flange bolt size
- MA - Mounting surface to top of shaft
- MB - Length of shaft flats
- MC - Length of follower
- MD - Shaft diameter
- ME - Centerline of shaft to retainer side of valve
- MF - Width of actuator mounting pad
- MG - Length of actuator mounting pad
- MH - Width of shaft flats
- MJ - Length between actuator mounting holes
- MK - Width between actuator mounting holes
- ML - Number of actuator mounting holes
- MM - Size of actuator mounting holes
- MN - Depth of actuator mounting holes
- N - Minimum allowable designed inside pipe diameter
- WG - Centerline of waterway to bottom of valve (wafer style)
- WTL - Weight of valve in pounds (Lug style)
- WTW - Weight of valve in pounds (wafer style)
- WE - Width of wafer body

### Class 150 . . . Wafer - Fig. No. 801 / Lug - Fig. No. 821

Size (inches)	A	WG	LG	H	J	K	L	M	WE	LE	MB	MC	MD	ME	MF	MG	MH	Mounting Pad	MN	WTW	WTL	N
3	1.88	2.75	3.08	3.13	12.00	6.00	4	3/8-11	5.38	6.00	1.00	1.98	.50	.91	1.70	4.00	.37	2	.75	27	30	2.90
4	2.12	3.38	3.97	4.02	12.88	7.50	8	3/8-11	6.75	8.63	1.00	1.93	.62	1.03	1.94	4.00	.44	2	.75	36	40	3.83
6	2.25	4.50	5.03	5.77	14.00	9.50	8	3/4-10	8.62	10.74	1.00	1.98	.75	1.19	2.00	4.00	.56	2	.75	49	59	5.77
8	2.50	5.69	6.19	7.45	15.12	11.75	8	3/4-10	10.88	13.13	1.00	2.32	1.00	1.31	2.25	4.00	.69	2	.75	72	80	7.62
10	2.81	6.75	7.78	9.27	17.00	14.25	12	7/8-9	12.98	16.00	1.00	2.44	1.25	1.53	2.44	6.25	.81	3	.75	108	134	9.56
12	3.19	7.75	9.03	11.05	18.00	17.00	12	7/8-9	15.23	18.76	1.50	3.45	1.50	1.76	2.62	6.25	1.00	3	.75	176	207	11.38
14	3.62	10.56	10.99	12.59	20.00	18.75	12	1-8	16.25	20.99	1.50	3.88	1.50	1.66	2.81	9.50	1.00	3	Thru	189	254	13.13
16	4.00	12.56	12.56	14.43	21.25	21.25	16	1-8	18.50	23.50	1.50	4.00	1.75	1.83	2.85	9.50	1.12	3	Thru	234	305	15.00
18	4.50	13.50	13.50	16.30	22.38	22.75	16	1 1/8-8	21.00	25.25	1.50	4.00	1.75	2.00	2.85	9.50	1.12	3	Thru	300	383	16.88
20	5.00	15.31	15.31	18.15	23.56	25.00	20	1 1/8-8	23.07	27.50	2.00	5.50	2.00	2.19	3.62	15.00	1.50	4	Thru	427	490	18.81
24	6.06	17.56	17.56	21.59	25.75	29.50	20	1 1/4-8	27.25	32.25	2.50	6.00	2.50	2.62	4.00	15.00	1.75	4	Thru	610	742	22.63

### Class 300 . . . Wafer - Fig. No. 803 / Lug - Fig. No. 823

Size (inches)	A	WG	LG	H	J	K	L	M	WE	LE	MB	MC	MD	ME	MF	MG	MH	Mounting Pad	MN	WTW	WTL	N
3	1.87	3.50	3.75	3.13	18.75	6.62	8	3/4-10	5.15	8.13	1.00	2.38	.62	.90	1.69	4.00	.44	2	.88	29	37	2.90
4	2.12	4.47	4.69	4.02	21.75	7.88	8	3/4-10	6.35	9.38	1.00	2.75	.75	1.03	1.95	4.00	.56	2	.88	41	57	3.83
6	2.31	5.78	6.04	5.77	23.25	10.62	12	3/4-10	8.67	12.12	1.00	2.75	1.00	1.19	2.13	4.00	.69	2	.88	55	81	5.77
8	2.87	6.87	7.14	7.45	30.75	13.00	12	7/8-9	10.82	14.76	1.00	3.25	1.25	1.31	2.50	6.25	.81	3	.88	80	120	7.63
10	3.25	8.98	8.98	9.27	32.50	15.25	16	1-8	12.97	17.25	1.50	3.88	1.50	1.53	2.88	6.25	1.00	3	.88	141	225	9.56
12	3.62	11.18	11.18	11.05	37.50	17.75	16	1 1/8-8	15.27	19.98	1.50	4.00	1.75	1.65	3.31	6.25	1.12	4	.88	210	335	11.88
14	4.50	12.50	12.50	12.59	40.00	20.25	20	1 1/8-8	16.25	22.49	2.00	5.50	2.00	2.19	3.75	16.00	1.50	4	Thru	278	405	12.50
16	5.25	13.19	13.19	14.43	40.00	22.50	20	1 1/4-8	18.50	25.00	2.50	6.00	2.50	2.56	4.25	16.00	1.75	5	Thru	368	573	14.33
18	5.75	14.93	14.93	16.30	42.00	24.75	24	1 1/4-8	21.00	27.25	2.50	6.00	2.50	2.81	4.25	16.00	1.75	5	Thru	465	723	16.13
20	6.12	15.63	15.63	18.15	44.00	27.00	24	1 1/4-8	23.00	29.49	2.50	6.25	3.00	3.00	6.12	18.00	2.00	5	Thru	712	925	17.94
24	7.00	18.31	18.31	21.59	48.00	32.00	24	1 1/2-8	27.25	35.00	2.50	7.50	3.50	3.44	7.00	18.00	2.25	6	Thru	1025	1375	21.56

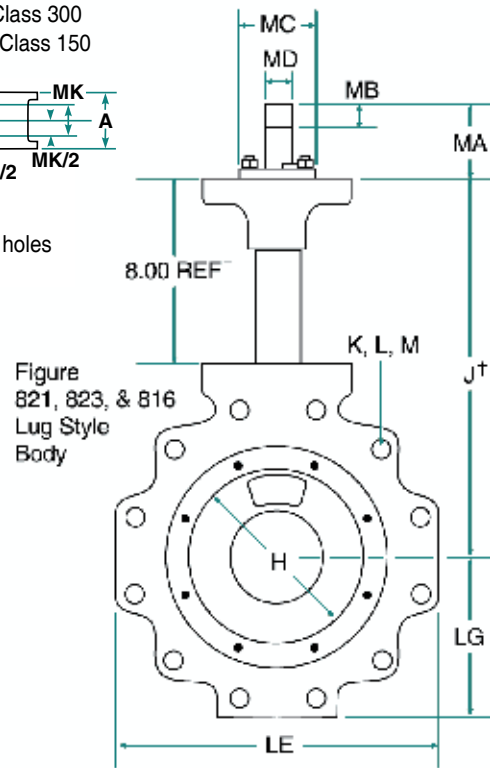
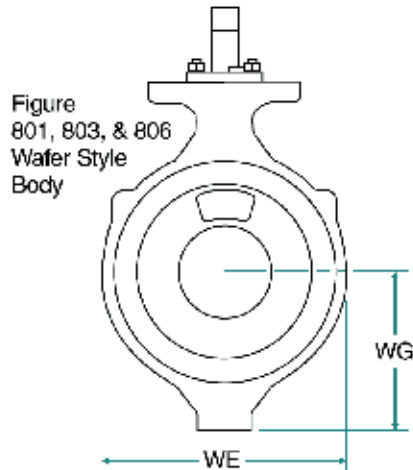
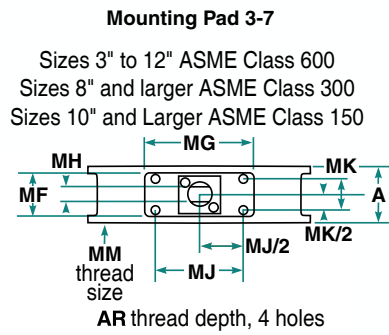
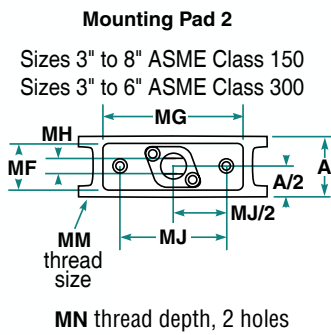

**Class 600 . . . Wafer - Fig. No. 806 / Lug - Fig. No. 816**

Size (inches)	A	LG	H	J†	K*	L	M*	LE	MB	MC	MD	ME	MF	MG	MH	Mounting Pad	MN	WTW	WTL	N
3	2.25	4.75	3.13	13.25	6.62	8	¾-10	8.12	1.00	2.75	.75	1.19	2.25	6.50	.56	2	.75	53	53	2.900
4	2.50	5.47	4.02	14.12	8.50	8	¾-9	10.25	1.00	2.75	1.00	1.33	2.50	6.50	.69	2	.75	64	64	3.826
6	3.06	7.74	5.77	16.12	11.50	12	1-8	13.49	1.00	3.25	1.25	1.60	3.06	6.50	.81	2	.75	134	134	5.769
8	4.00	8.80	7.45	17.50	13.75	12	1½-8	15.49	1.50	3.88	1.50	2.06	4.00	9.50	1.00	3	1.00	247	247	7.439
10	4.62	10.83	9.27	19.88	17.00	16	1¼-8	19.50	2.00	5.50	2.00	2.12	4.62	16.00	1.50	4	1.50	453	453	9.312
12	5.50	12.38	11.05	21.12	19.25	20	1¼-8	21.75	2.50	6.00	2.50	2.81	5.50	16.00	1.75	4	1.50	650	650	11.062
14	6.12	14.00	12.59	22.25	20.75	20	1¾-8	23.75	2.50	6.25	3.00	3.19	6.12	18.00	2.00	5	1.50	940	940	12.12
16	7.00	15.75	13.70	23.75	23.75	20	1½-8	26.71	2.50	7.50	3.50	3.38	6.75	18.00	2.25	5	Thru	**	**	13.80
18	7.25	17.62	15.68	24.75	25.75	20	1¾-8	28.75	2.50	7.50	3.50	3.75	7.13	18.00	2.25	5	Thru	**	**	15.25
20	8.50	21.25	17.75	26.12	28.50	24	1¾-8	31.75	3.50	8.00	4.00	4.38	8.00	18.00	2.75	6	Thru	**	**	17.00
24	9.13	22.00	18.96	29.00	33.00	24	1¾-8	39.50	3.50	9.00	4.50	5.25	9.13	18.18	3.25	7	Thru	**	**	18.00

\* Wafer valves utilize lug bodies with clearance holes.

\*\* Consult factory

† Dimensions are for semi-cryogenic valves in applications down to -180°F. For full-cryogenic applications, specify extension length or consult factory to determine appropriate extension.

**Mounting Pad Dimensions**

Mounting Pad	MA	MJ	MK	ML	MM
2	3.25	5.00	1.00	2	½-13
3	3.50	8.00	1.38	4	¾-11
4	5.75	13.00	2.00	4	1-8
5	5.75	15.00	3.00	4	1-8
6	7.50	15.00	4.00	4	1¼-7
7	7.50	15.00	3.75	4	1¼-7

**Pressure/temperature rating for standard body material**

Operating Temperature °F	Maximum Working Pressure - PSIG		
	Class 150	Class 300	Class 600
-425 to -20	275	720	1440
-20 to 100	275	720	1440
200	240	620	1240
300	215	560	1120

# Tufline Semi-Cryogenic and Cryogenic High Performance Butterfly Valves

## Materials of Construction:

Part Description	Material
Body <sup>1</sup>	A351 Grade CF8M SS
Bonnet / Extention <sup>1</sup>	A351 Grade CF8M SS / A312 Grade TP316 SS
Disc <sup>1</sup>	A351 Grade CF8M SS /Electroless Nickel Plated
Retainer <sup>1</sup>	A240 Type 316 SS
Follower	A351 Grade CF8M SS
Follower Stud	A193 Grade B8 SS
Follower Nut	A194 Grade 8 SS
Lockwasher	302 SS
Disc Spacer <sup>1</sup>	A747 Grade CB-7CU SS
Taper Pin <sup>1</sup>	A479 Type XM-19 SS (Nitronic 50)
Hollow Pin <sup>1</sup>	A479 Type 316 SS
Bearing <sup>1</sup>	A240 Type 316 SS, Electroless Nickel Plated
Shaft <sup>1</sup>	A564 Type 630, Cond. H1150-M (17-4PH SS) <i>(Down to -325° F)</i> B637 Grade UNS N07718 (inconel 718) <i>(Down to -425° F)</i>
Seat <sup>1</sup>	A351 Grade CF8M SS / PCTFE Insert
Seat Gasket <sup>1</sup>	Flexible Graphite
Retainer Screws <sup>1</sup>	A193 Grade B8 SS
Packing <sup>1</sup>	PTFE (Reinforced Graphite is Optional)
Packing Ring <sup>1</sup>	A276 Type 316 SS
Gland	A276 Type 316 SS
Shaft Retaining Ring	302 SS
Sealing Cap <sup>1, 2</sup>	A240 Type 316 SS
Cap Seal <sup>1, 2</sup>	PTFE (Reinforced Graphite optional)
Sealing Cap Bolt <sup>2</sup>	A193 Grade B8 SS

1. Wetted Part

2. 14" and larger valves only

# Tufline Semi-Cryogenic and Cryogenic High Performance Butterfly Valves

## How to Specify

Example:

8" - 8 0 3 SC - 6 6 N - S T - C T 4 - G - O

1	Nominal Size	Code
	3"	3"
	4"	4"
	5"	5"
	8"	8"
	10"	10"
	12"	12"
	14"	14"
	16"	16"
	18"	18"
20"	20"	
24"	24"	

2	Valve Series	Code
	Tufline High Performance Butterfly Valve	8

3	Body Style	Code
	Wafer Style	0
	Lug Style (Bi-directional Dead End)	2

4	Pressure Class	Code
	ASME Class 150	1
	ASME Class 300	3
	ASME Class 600	6

5	Bonnet Type	Code
	Semi-Cryogenic <sup>1</sup>	SC
Full Cryogenic <sup>2</sup>	FC	

6	Body / Bonnet Material	Code
	A351 Grade CF8M SS	6

7	Disc Material	Code
	A351 Grade CF8M SS / ENP	6

8	Shaft Material	Code
	A564 Type 630, Cond. H1150-M <sup>3</sup>	N
B637 Grade UNS N07718	X	

9	Bearing Material	Code
	A240 Type 316 SS / ENP	S

10	Packing Material	Code
	PTFE (V-Rings)	T
Graphite <sup>5</sup>	G	

11	Seat Material	Code
	A351 Grade CF8M SS / PCTFE	CT4

12	Operation	Code
	None	N
	Lever (Locking Device Standard)	L
	Enclosed Manual Gear	G
Power Actuator (Specify)	A	

13	Service Requirements	Code
	General Service	Blank
Oxygen	O	

General Notes:

1. Semi-cryogenic bonnets are standard with an 8" extension.
2. Cryogenic bonnet extension length to be specified by the customer.
3. A564 Type 630, Condition H1150-M (17-4PH SS) shafts can be used in applications down to -325°F.
4. B637 Grade UNS N07718 (Inconel 718) shafts are required for applications from -326°F down to -425°F.
5. Specifying graphite packing, seals, and gaskets does not permit the use of this valve in applications where fire tested valves are required.

# XOMOX®

CRANE ChemPharma Flow Solutions™

XOMOX Headquarters  
4444 Cooper Road,  
Cincinnati, OH 45242, U.S.A.  
Tel.: (513) 745-6000  
Fax: (513) 745-6086

XOMOX International GmbH & Co. OHG  
Von-Behring-Straße 15,  
D-88131 Lindau/Bodensee  
Tel.: (49) 8382-702-0  
Fax: (49) 8382-702-144

**CRANE**

ChemPharma Flow Solutions



brands you trust.

CRANE ChemPharma Flow solutions Include: Pipe - Valves - Fitting - Actuators - Pumps

**DEPA**

**PSI**  
LINE PIPE SYSTEMS

**ResistoPure**

**Saunders**  
the science inside

**ELRO**

**RESISTOFLEX**

**revo**

**XOMOX**

CP-XOMOX-CRYOGENICBFV-BU-EN-CI-5/09-PN333767

Crane Co., and its subsidiaries cannot accept responsibility for possible errors in catalogues, brochures, other printed materials, and website information. Crane Co. reserves the right to alter its products without notice, including products already on order provided that such alteration can be made without changes being necessary in specifications already agreed. All their trademarks in this material are property of the Crane Co. or its subsidiaries. The Crane and Crane brands logotype (Xomox®, Saunders®, Resistoflex®, Resistopure™, PSI®, DEPA®, ELRO®, REVO®) are registered trademarks of Crane Co. All rights reserved.